

# *Irradiation Chamber BS-05*

## *Manual*

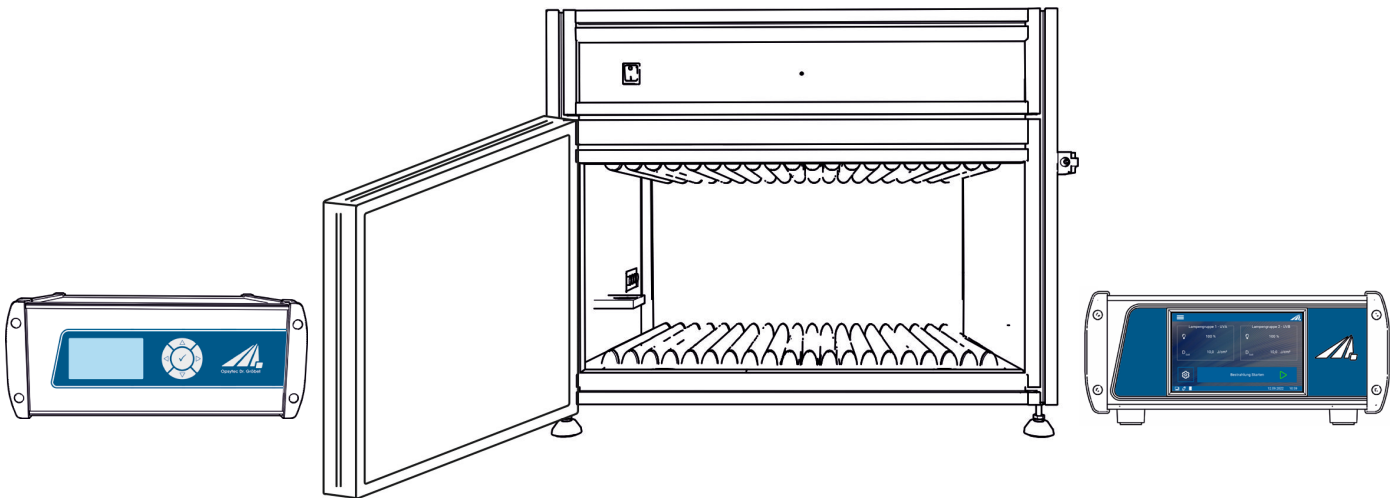

Opsytec Dr. Gröbel GmbH  
Am Hardtwald 6-8  
D-76275 Ettlingen

Phone: +49(0)7243 / 9 47 83-50  
info@opsytec.com

# 1 Table of Contents

<b>1</b>	<b>Table of Contents</b> .....	<b>2</b>
<b>2</b>	<b>Preface</b> .....	<b>4</b>
<b>3</b>	<b>Quick start guide</b> .....	<b>5</b>
<b>4</b>	<b>Guidelines and standards</b> .....	<b>7</b>
<b>5</b>	<b>Identification</b> .....	<b>8</b>
5.1	Manufacturer, Ordering of Spares and Customer Service .....	8
5.2	Change History .....	8
5.3	Copyright .....	8
5.4	Identification of the Device.....	8
5.5	Intended Use .....	9
5.6	Foreseeable Misuse .....	10
5.7	Legal Information .....	10
<b>6</b>	<b>General</b> .....	<b>11</b>
6.1	Information about this Manual .....	11
6.2	Information about the Symbols.....	13
6.3	Owner/Operator Information .....	16
6.5	Personal Protective Equipment .....	19
<b>7</b>	<b>Safety Information and Residual Risk</b> .....	<b>20</b>
7.1	General .....	20
7.2	Safety Information Concerning Normal Operation .....	21
7.3	Radiation Safety .....	23
7.4	Safety Information Concerning Service and Repair Work.....	23
<b>8</b>	<b>System Description</b> .....	<b>25</b>
<b>9</b>	<b>Commissioning</b> .....	<b>28</b>
9.1	Installing and replacing a lamp .....	30
9.2	Attenuator* .....	31
9.3	Commissioning and Use of inter box* .....	32
<b>10</b>	<b>Operating</b> .....	<b>33</b>
<b>11</b>	<b>Operation with a UV-Mat Touch</b> .....	<b>35</b>
11.1	Switch on / Switch off.....	35
11.2	Introduction to the user interface .....	36
11.3	Setting the setpoints .....	37
11.4	During irradiation .....	40
11.5	After irradiation .....	43
11.6	Data recording .....	43
11.7	User settings.....	44
11.8	Information.....	49
11.9	Error messages .....	51

---

<b>12</b>	<b>UV-MAT operation</b> .....	<b>52</b>
	12.1 Switching on .....	53
	12.2 Switching off .....	53
	12.3 Settings menu.....	58
	12.4 Dimming menu.....	63
	12.5 Internal settings .....	64
<b>13</b>	<b>USB logging* and REMOTE operation*</b> .....	<b>66</b>
	13.1 Software Installation .....	67
	13.2 Connecting with the PC .....	67
<b>14</b>	<b>Software – UV-MAT Control for UV-MAT Touch*</b> .....	<b>68</b>
	14.1 Working with the software.....	70
<b>15</b>	<b>Technical Data</b> .....	<b>72</b>
<b>16</b>	<b>Maintenance</b> .....	<b>79</b>
	16.1 Calibration.....	81
	16.2 Changing the UV-MAT Touch battery .....	81
<b>17</b>	<b>Spare Parts</b> .....	<b>82</b>
<b>18</b>	<b>Declaration of Conformity</b> .....	<b>83</b>
<b>19</b>	<b>NOTES</b> .....	<b>84</b>

## 2 Preface

Dear Customer!

Thank you for choosing a product manufactured by us!

Please take your time to read this manual carefully. Please pay special attention to the safety instructions.

This is the condition for safe handling and safe operation of the system and its components.

If you have any questions that you do not find answered in this manual, please call us and we will be pleased to assist you. In addition, we always welcome any suggestions or proposals for improvement.

Our products undergo constant advanced development; therefore, there may be minor differences between your system and the illustrations given in this Operating Manual.



Please note that the manufacturer of this device accepts no liability for the quality of the irradiation result of the irradiated material, as this depends on many factors. Always check the irradiation result after irradiation and adjust the irradiation if necessary.

The information in this operating manual has been checked several times for accuracy. However, Opsytec Dr. Gröbel GmbH assumes no responsibility for inaccuracies and reserves the right to change this document. The latest version of the operating instructions can be found at [www.opsytec.com](http://www.opsytec.com).

© 2024

Opsytec Dr. Gröbel GmbH

Am Hardtwald 6-8

D – 76275 Ettlingen

Tel.: +49(0)7243 / 9 47 83-50

[info@opsytec.com](mailto:info@opsytec.com)

All rights reserved. Re-printing, also extracts, only permitted with written consent of Opsytec Dr. Gröbel GmbH.

This is a translation of the original operating manual.

### 3 Quick start guide

The quick guide should demonstrate the installation and some of the system functions to trained personnel. You will find the detailed instructions on page 28. Please pay special attention to the safety instructions given in the complete manual.



As an alternative to the UV-MAT Touch, we offer the UV-MAT. You will find the operation in separate chapters and refer to only one type.

Commissioning:

- Unpack all components and remove the packaging materials.
- The irradiation chamber is supplied with unmounted UV lamps. You need to install them.
- The irradiation chamber is delivered with UV lamps not mounted. You must install these. The irradiation chamber has two lamp groups (even and odd) lamps. Always alternate the lamps when using two different types. Open the front door and insert the lamps into the lamp sockets. This is done by rotating the lamp 90°.

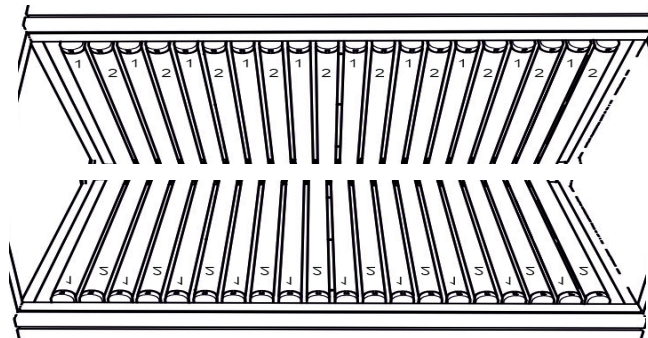

- Connect the sensor(s):
  - Mount the sensor(s) in the left-hand sensor holder inside the irradiation chamber.
  - Remove sensor caps.
  - Route the sensor cable through cable feedthrough in the rear side of the irradiation chamber.
- Connect the sensor with the UV-MAT. Pay attention to the assignment of the sensors here.
  - The sensor connected to channel 1 controls lamp group 1.
  - The sensor connected to channel 2 controls lamp group 2.
  - If there is only one lamp group, connect the sensor to channel 1.
- Connect the irradiation chamber to the mains voltage.
- Switch on the irradiation chamber with the mains switch.
- The irradiation is controlled by the UV-MAT irradiation control unit.

- Open the front door of the irradiation chamber and place the objects to be irradiated into the irradiation chamber.
- Make sure that the built-in sensor is not covered during dose-controlled irradiation.
- Close the front door of the irradiation chamber, otherwise the UV lamps will not switch on.
- Select the dose-controlled or time-controlled operating mode.
- Set the desired dose or time. Note the assignment of the sensors and the lamp group. If, for example, a UVA sensor is connected to channel 1, UVA lamps must also be inserted in lamp group 1.
- Start the irradiation
- If necessary, check the sensor factor and the channel settings.

Start the irradiation through the UV-MAT. At the end of the irradiation, open the front door of the irradiation chamber and carefully remove the irradiated objects. Do not forget to switch off the irradiation chamber.



Information on safety instructions can be found on page 20.

Information on commissioning can be found on page 28.

## 4 Guidelines and standards



The system is machinery under Annex II A of the Machinery Directive and is therefore delivered with a declaration of conformity and with a CE mark (in accordance with the Machinery Directive).

Directives	
EC Directives	06/42/EC (Machinery) (partially observed) 2014/30/EC (EMC) 2014/35/EC (Low voltage)
Harmonized standards	
EN ISO 12100:2010	Safety of Machinery – General Principles for Design Risk Assessment and Risk Reduction
DIN EN 60204-1 (VDE 0113-1):2019-06	Safety of machinery - Electrical equipment of machines - Part 1: General requirements
EN 61000-6-2:2005	Electromagnetic Compatibility (EMC) – Part 6-2: Immunity for Industrial Environments
EN 61000-6-4:2007 + A1:2011	Electromagnetic Compatibility (EMC) – Part 6-4: Emission Standard for Industrial Environments

## 5 Identification

### 5.1 Manufacturer, Ordering of Spares and Customer Service

Opsytec Dr. Gröbel GmbH  
 Am Hardtwald 6-8  
 D – 76275 Ettlingen  
 Tel.: +49(0)7243 / 9 47 83-50  
 info@opsytec.com  
 www.opsytec.com

### 5.2 Change History



We reserve the right to make changes in content. Opsytec Dr. Gröbel GmbH is not liable for any errors in this documentation. No liability shall be accepted for indirect damages arising from the delivery or use of this documentation, in as far as this is legally permissible.

Version	Changed by	Date	Change
3.0.0	Paravia	27.08.2020	UV-MAT and PC control added
3.0.1	Paravia	01.12.2020	Minor corrections
3.0.2	Paravia	28.01.2021	Remote Switch USB

### 5.3 Copyright



Opsytec Dr. Gröbel GmbH shall retain the copyright for these operating manual. The operating manual is intended for the owner/operator and his personnel.

#### **Copyright in accordance with DIN ISO 16016:**

Reproduction and copying of this document, use and disclosure of its contents are prohibited unless expressly authorized.  
 Non-compliance may result in a claim for damages. All rights reserved in case of registration of patent, utility patent, or design patent.  
 Contraventions may be subject to prosecution.

### 5.4 Identification of the Device

For internal use at customer site:

Description of machinery:	Irradiation chamber BS series
Year of construction:	.....
Machine No.	.....
Project no.	.....



## 5.5 Intended Use

The irradiation chamber is a controlled radiation-source for different UV applications like

- Irradiation of bacterial and cell cultures
- PCB and wafer irradiation & cleaning
- Accelerated aging of plastics and similar materials with UV
- Curing / Hardening under inert conditions

It can be equipped with different UV lamps emitting UVA, UVB, UVC or light.

The system is exclusively intended for industrial use. It is forbidden to use the devices in explosive environments or for general illumination.

- Installation, commissioning, operation, maintenance and service works must solely be performed by trained and educated, qualified personnel, which observes all safety regulations and standards.
- Responsibility: Damages resulting from unintentional or unauthorized interventions terminate every right, to raise warranty or liability claims against the manufacturer.
- Guarantee exclusion: The use of any non-original parts voids the guarantee.
- Environmental protection: Defect parts, which may contain environmentally harmful substances, must be disposed of accordingly.
- During the operation a high-energy UV and/or visible radiation is generated.
- Operation is only permitted in a dry environment. The installation is horizontal.
- Only suitable for the operation in closed rooms.
- Prior to opening, the system must be disconnected from the voltage and it must be checked that there is no voltage present.
- Wear gloves for maintenance, cleaning and exchanging the lamps and optical components.
- The system must not be cleaned when in operation.
- The door must not be opened during irradiation. The front door is monitored. Should it be opened during the irradiation, the UV lamps will automatically switch off. Since this is done with a slight delay, the user will possibly be briefly exposed to UV radiation.
- Any other use than the above mentioned, results in damages to the product. Furthermore, it is associated with risks such as short circuits, fire and electric shocks. The entire device must not be changed and/or modified! The safety notes must be observed at all times.

	<b>⚠ CAUTION</b>
	<p><b>System may fall down! Device damaging and personal injuries are possible</b></p> <ul style="list-style-type: none"><li>• Always carry the system with two persons.</li></ul>

## 5.6 Foreseeable Misuse

The following is considered foreseeable misuse:

- Operation of the device without safety devices and equipment.
- Activities of uninstructed personnel on the device.
- Non-compliance with the operating instructions of the owner/operator.
- Ignoring of the operating manual.
- Any other use outside the intended specified use.

## 5.7 Legal Information

### 5.7.1 Limitation of Liability

All the information in this manual was compiled with consideration of the currently valid standards and regulations, of the technical standard and our long-standing knowledge and experience.

The manufacturer shall not be liable for damage in the event that:

- This manual is ignored,
- The device is improperly used,
- Untrained personnel is deployed,
- Untrained personnel operates the machine incorrectly,
- Unauthorized modifications are made,
- Technical changes are made,
- Non-approved spare parts are used.

We shall not be liable for common faults of the device caused by power outage or failure of the control system.

The actual scope of delivery may be different than the explanations and pictures in this manual in case of special versions, when additional options are ordered or due to the latest technical changes.

The obligations agreed in the delivery contract, as well as the legal requirements valid at the time the contract was concluded shall apply.

### 5.7.2 Declaration of conformity

The declaration of conformity is in the annex or can be requested from the manufacturer.

### 5.7.3 Warranty Terms

The warranty terms and guarantee conditions are governed by the German Civil Code (BGB). The warranty period is one year unless otherwise agreed in the purchase documents.

## 6 General

### IMPORTANT SAFETY PRECAUTIONS

WARNING - Always observe the following basic precautions when using electrical equipment:

- (a) Read all instructions before using the equipment.
- b) This equipment is to be used only by qualified and trained personnel.  
Refer to the training section in this manual.
- c) Know how to turn off the product. Become thoroughly familiar with the familiarize yourself with the controls.
- d) Stay alert - watch what you are doing.
- e) Do not operate the product when you are tired or under the influence of alcohol or drugs.
- f) Keep danger area away from all persons.
- g) Do not place the product on an unstable surface.
- h) Follow the maintenance instructions given in the operating manual.
- i) Keep these instructions in a safe place.

### 6.1 Information about this Manual

This manual intends to make handling of this system and its components safe and efficient. The manual is part of the system and must be kept in its immediate vicinity where it is accessible for the personnel at any time.

This documentation contains the necessary information for the intended use of the described system. It is intended for technically qualified personnel who have been especially trained for operation, laboratory use, quality assurance, service and repair.

The personnel must have read this manual carefully and understood its content before commencing any work. The basic condition for safe working is observation of all stated safety information and operating instructions in this manual.

Knowledge and technically faultless implementation of the instructions, safety requirements, safety information and warnings are a condition for safety in operation, service and repair. Only qualified personnel has the required professional knowledge to apply the safety requirements, safety information and warnings stated in this operating manual in a general way correctly in a concrete situation.

In addition, the local accident prevention regulations and general safety regulations apply for the area of application of the system.

Illustrations in this manual serve the purpose of general understanding; they may differ from the actual version.

Apart from this manual the instructions for the installed components included in the appendix apply.

This operating manual cannot take any possible case of maintenance into account. If you need further information or if special problems occur that are not treated extensively enough in this manual please request the required information from the manufacturer.



For a simple description, the above mentioned components are collectively referred to as system.

## 6.2 Information about the Symbols

### 6.2.1 Safety Instructions

In this manual, safety information is indicated by means of symbols. Safety information is preceded by signal words that indicate the scope of risk.

To avoid accidents and damage to persons or property, always follow the information and act prudently.

Throughout the text, you will find the following pictograms with the following meanings:

	<b>⚠ DANGER</b>
	<p><b>Imminent danger</b> Possible consequences: death or most serious injuries.</p> <ul style="list-style-type: none"> <li>• Prevention</li> </ul>

	<b>⚠ WARNING</b>
	<p><b>Dangerous Situation</b> Possible consequences: death or most serious injuries.</p> <ul style="list-style-type: none"> <li>• Prevention</li> </ul>

	<b>⚠ CAUTION</b>
	<p><b>Possible Situation</b> Possible consequences: slight or minor injuries. Sometimes also used for warning of material damage.</p> <ul style="list-style-type: none"> <li>• Prevention</li> </ul>



#### Note

Information for use or useful important information

### 6.2.2 Prohibition Signs



General "Prohibited-sign"

### 6.2.3 Warning Signs



Warning of optical radiation  
(such as UV, IR, or visible radiation)



Warning of hot surface!



Warning of electricity!

### 6.2.4 Attention



Wear eye protection!



Opaque eye protection must be worn!



Disconnect mains plug from electrical outlet!



Disconnect before carrying out maintenance or repair!



Use hand protection!



Wear foot protection!



Refer to instruction manual/booklet

### 6.2.5 Optional functions

- \* Optional functions, not available for every system

### 6.3 Owner/Operator Information

The System is used in the commercial sector. The owner/operator of the system is therefore subject to the legal obligations concerning work safety.

In addition to the safety information in this manual, the generally applicable regulations valid for the application area of the system concerning safety, prevention of accidents and for protection of the environment must be noted and complied with.

The following applies in particular:

The owner/operator must acquire information about the valid occupational health and safety information and in a risk assessment determine additional hazards incurred due to the special operating conditions at the location of use of the system. He must implement these in the form of operating instructions for operation of the system and specifically for the individual work stations.

The owner/operator is obliged to check during the entire lifetime of the system whether the operating instructions that he generated comply with the current status of the regulations and update them if necessary.

The owner/operator must assign and define the responsibilities for installation, operation, rectification of faults, service and cleaning unambiguously.

The owner/operator must ensure that all personnel dealing with the system have read and understood this manual. Furthermore, he is obliged to provide personnel training in regular intervals and provide information about risks.

The owner/operator must provide the required personal protective equipment for his personnel. Furthermore, the owner/operator is responsible that the system is always in faultless technical condition. To ensure this, the service intervals specified in this manual and in the technical documents for the individual systems must be observed and all safety installations must be checked regularly for function and completeness.

The owner/operator must have all safety devices checked regularly for function and completeness.



The owner/operator must ensure that the operating personnel have knowledge about first aid measures and local rescue installations.





## 6.4 Personnel Requirements

The maximum number of qualified professionals allowed to be at the site at the same time: 2

### 6.4.1 Qualifications

	 <b>WARNING</b>
	<p><b>Risk of injury when personnel are insufficiently qualified!</b></p> <p>If unqualified personnel carries out work on the system or stays in the danger area of the system risks arise that may cause severe injuries and serious material damage.</p> <ul style="list-style-type: none"> <li>• Have all activities carried out only by personnel qualified for the activity.</li> <li>• Keep unqualified personnel away from the danger area.</li> </ul>

 	 <b>WARNING</b>
	<p><b>Risk of injury when touching live parts or hot surfaces</b></p> <p>Generally, low voltage devices like this system can have dangerous live parts and hot surfaces. All works for transportation, installation, commissioning, start-up and maintenance must be performed by respectively trained and responsible, qualified personnel (in accordance with EN 50110-1 (VDE 0105-100); IEC 60364). Inappropriate behavior can lead to serious injuries or damages.</p> <p>During the irradiation the LAMP temperature may rise up to approx. 60° C. Caution - risk of burns.</p>

Below, this manual lists the qualifications of the personnel for the various areas of activity:

#### 6.4.2 Electrically skilled person

Due to their professional training, knowledge and experience and knowledge of the relevant standards and regulations, electrically skilled persons are able to carry out work on electrical systems and to recognize and avoid risks independently.

Electrically skilled persons are specially trained for the work environment where they are working and they know the relevant standards and regulations. Electrically skilled persons must fulfil the requirements of the valid legal regulations for accident prevention.

#### 6.4.3 Qualified person

Qualified persons are trained or can be trained by Opsytec Dr. Gröbel GmbH in extended operation and parameterization of the system as well as in execution of preventive service work.

In addition, due to their technical training, knowledge and experience and knowledge of the relevant standards and regulations, they are able to carry out work they have been assigned and to recognize and avoid possible risks independently.

#### **6.4.4 Operators**

Operators use and operate the system in the scope of the intended use. They are trained by the owner/operator in the work assigned to them and informed about possible risks.

#### **6.4.5 Training and Qualification of Personnel**

In regular instructions and training, operating personnel must be informed about the special risks when working with and handling the system.

The instruction and training should have the following content:

- Hazards when working with the system in normal operation.

- Hazards in connection with service, repair and cleaning activities.

- Conduct to minimize consequences of accidents.

- Conduct in case of accidents.

- Rescue of injured persons.

- Working without personal protective equipment may cause health damage. The company supervisor is instructed to pay attention that personnel are wearing personal protective equipment.

- Particular hazards when working on the electrical system.

Instruction and training must be carried out in regular intervals by the owner/operator. For better tracking, execution of instruction and training should be recorded.

## 6.5 Personal Protective Equipment

The purpose of personal protective equipment is to protect the personnel from risks that might affect his safety or health when working.

When executing various activities on and with the system, the personnel must wear personal protective equipment. This will be pointed out again in the individual chapters of this manual. Below, personal protective equipment is explained:

### 6.5.1 Protective Gloves

Protective gloves are used to protect hands from visible and invisible radiation, friction, abrasion, stabs and deep injuries.

### 6.5.2 Protective Goggles

Protective goggles are used to protect eyes from intense visible and invisible radiation. Safety glasses and storage boxes can be ordered from Opsytec Dr. Gröbel GmbH, Am Hardtwald 6-8, 76275 Ettlingen or UVEX AREITSSSCHUTZ GMBH, Würzburger Str. 181 - 189, 90766 Fürth, Germany:

Protective eyewear part number: 9169065

Storage box part number: 9957502

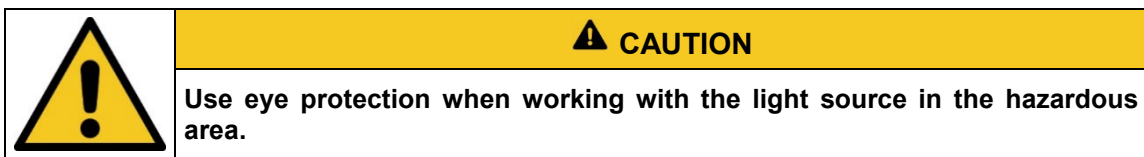

### 6.5.3 Safety Boots



Safety boots are used as protection from heavy parts falling down and slipping on slippery surfaces.

## 7 Safety Information and Residual Risk



### 7.1 General



The system is state-of-the-art and has been built in compliance with recognized safety regulations. Nonetheless, its use may constitute risks for life and limb of the operating and repair personnel (service personnel) or third parties or impairments to the machine. Operate the system only when its safety devices are in faultless condition. Disruptions that impair its safety must be rectified at once.



The following safety information must be strictly observed to prevent damage to the machine and personal injury!

 <b>WARNING</b>	
	<p><b>Risk of injury when personnel do not read the operation manual!</b></p> <p>Prior to commissioning and operation, read the operation manual completely. Read all safety information and instructions. Negligence concerning safety information and instructions may cause electric shock and/or severe injuries.</p>

## 7.2 Safety Information Concerning Normal Operation

	 <b>DANGER</b>
	<p><b>Danger to life</b></p> <p>Danger to life occurs when the system is operated with defective or absent safety devices.</p> <ul style="list-style-type: none"> <li>• The system should be operated only when all protective devices and safety-related installations are present and in working condition. The operator of the machine is obliged to check the safety devices for proper function regularly before production is started.</li> </ul>

	 <b>CAUTION</b>
	<p><b>Risk of Damage</b></p> <ul style="list-style-type: none"> <li>• Skin fat and dirt are absorbent in the UV and visible spectral range.</li> <li>• Avoid fingerprints on the optically active sensor surface. If necessary, the components must be cleaned carefully with Isopropyl.</li> <li>• Use safety goggles and gloves when working inside sample room of the BS-02 irradiation chamber.</li> </ul>

	 <b>CAUTION</b>
	<p><b>Risk of Damage</b></p> <p>The system warms up during operation.</p> <ul style="list-style-type: none"> <li>• Make sure that there is an adequate air circulation at the installation site.</li> <li>• Air vents in the device housing must not be covered.</li> <li>• Provide enough fresh air for cooling the BS-02. The access of the air is at the bottom of the device. Place the lamp on a hard surface.</li> </ul>

For activities in normal operation a brightness of at least 300 Lux must be provided.

Access to the machine is only permitted for operating personnel and instructed personnel.

Operation the machine is only permitted for instructed operating personnel.



Removing or disabling protective devices is not allowed during operation of the system.

If any protective devices or equipment fail or have become faulty, this must be reported to the operations supervisor immediately. He will decide about further procedure.





Please note that the manufacturer of this device accepts no liability for the quality of the irradiation result of the irradiated material, as this depends on many factors. Always check the irradiation result after irradiation and adjust the irradiation if necessary.



### 7.3 Radiation Safety



	 <b>WARNING</b>
	<p><b>Risk of eye injury</b>  <b>UV-radiation is harmful! Always wear suitable safety glasses. Avoid direct exposition.</b></p> <p>This product is equipped with UV and visible high intensity LAMPs. There is a risk of photo-chemical or thermal damage of the eye, retinal damage of the eye and erythema. The operating staff is to be trained appropriately.</p> <p>For protection of the operating staff, do not look into the UV light and do not expose the skin continuously to UV radiation.</p> <p>Note: In case of a malfunction, the UV light can be switched on, even though the status or the trigger output does not signalize this. Before working with the device, please check that the lamps are switched off.</p>

### 7.4 Safety Information Concerning Service and Repair Work

	 <b>WARNING</b>
	<p><b>Risk of injury! High Weight!</b>  Always carry the system with two persons.</p>

	 <b>WARNING</b>
	<p><b>Risk of injury when touching live parts</b>  Before opening the system, disconnect all components from the supply voltage and check that no voltage is present.</p>

	 <b>CAUTION</b>
	<p><b>Risk of Damage</b></p> <ul style="list-style-type: none"> <li>• Switch off the control unit prior to connecting / disconnecting accessories. Due to the operating voltage of the unit, the accessories can get damaged.</li> <li>• Unplugging &amp; plugging of signal cables during the operation is strictly forbidden!</li> </ul>

 CAUTION	
	<p><b>Risk of Damage</b></p> <ul style="list-style-type: none"><li>• Skin fat and dirt are absorbent in the UV and visible spectral range.</li><li>• Avoid fingerprints on the optically components, sensor surfaces, Lamps and reflectors. If necessary, the components must be cleaned carefully with Isopropyl.</li></ul>

Service, repair and cleaning work must only be carried out by authorized and specifically trained professionals. The system must be power-free and secured before major work is carried out (including cleaning).

Carry out the prescribed setting, service and inspection work according to schedule. If you need further information or if special problems occur that are not treated extensively enough in this manual please request the required information from the manufacturer.

Only specialized electricians may perform work on electrical equipment.

Safety devices may only be removed during service and repairs, if the system was previously switched off and brought into a safe condition.

For service and maintenance work, important safety installations may not be functional. Work of this kind therefore requires special caution.



## 8 System Description

The irradiation chamber is a controlled radiation-source. 40 UV-tubes of 18 Watts/20 Watts each can be installed. These tubes can be in the spectral range of UVA, UVB or UVC. Two spectral ranges can be combined and both types can be turned off separately (optional). The optional integrated dose controller UV-MAT and the UV-sensors allow independent control of the dose of the 2 possible types of UV-irradiation.

The UV-MAT serves for the independent dosage control of UV irradiation. Due to this sensitive area of application it is equipped with several safety functions.

Thus the microcontroller system, the maximum irradiation time and the sensor function is observed. The radiation is measured with two sensors. It is possible to enter a calibration factor in order to display the radiation value in another position than the sensor position.

The working with the equipment is very simple because of the use of modern microcontroller technique.

Changing the tubes and sensors is easily accomplished using the front lid. The power switch is at the front, the power plug is at the back of the equipment.

In the completely closed and monitored irradiation chamber, the operating personnel are fully protected from the UV radiation.

The components at a glance:

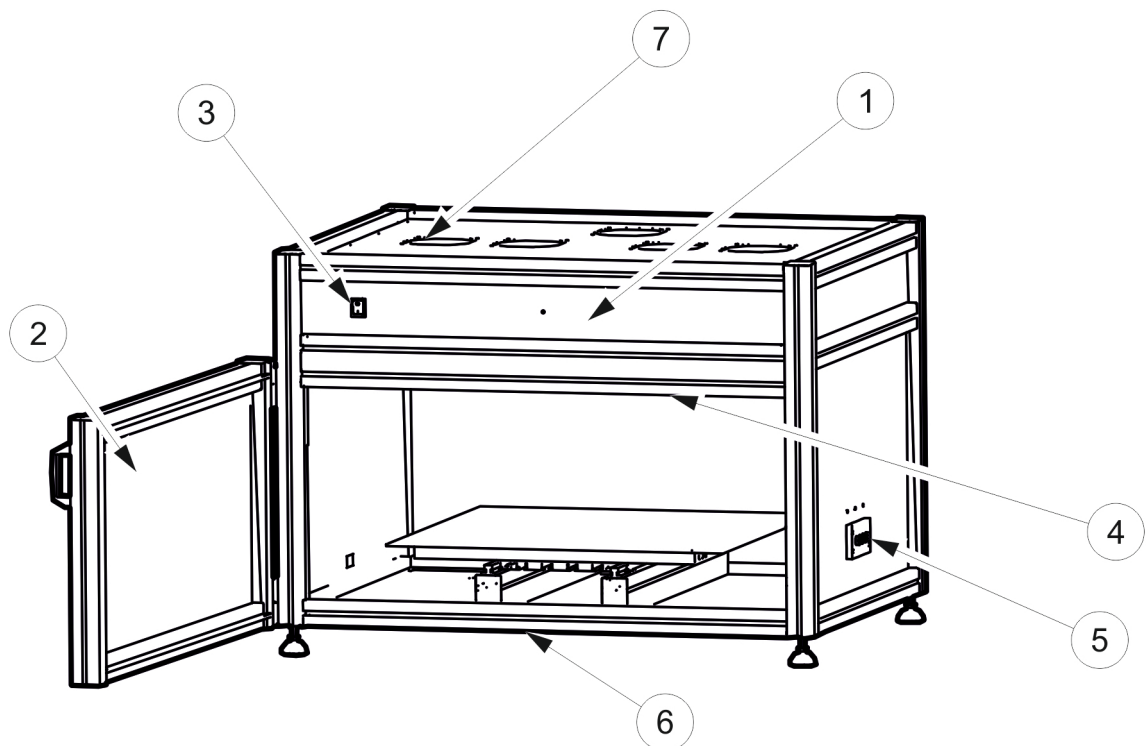

Pos.	Designation	Pos.	Designation
1	Irradiation chamber	2	Front door
3	Main switch	4	Lamps
5	Cable feedthrough	6	Cooling air inlet
7	Cooling air outlets		

Rear view and ventilation concept:

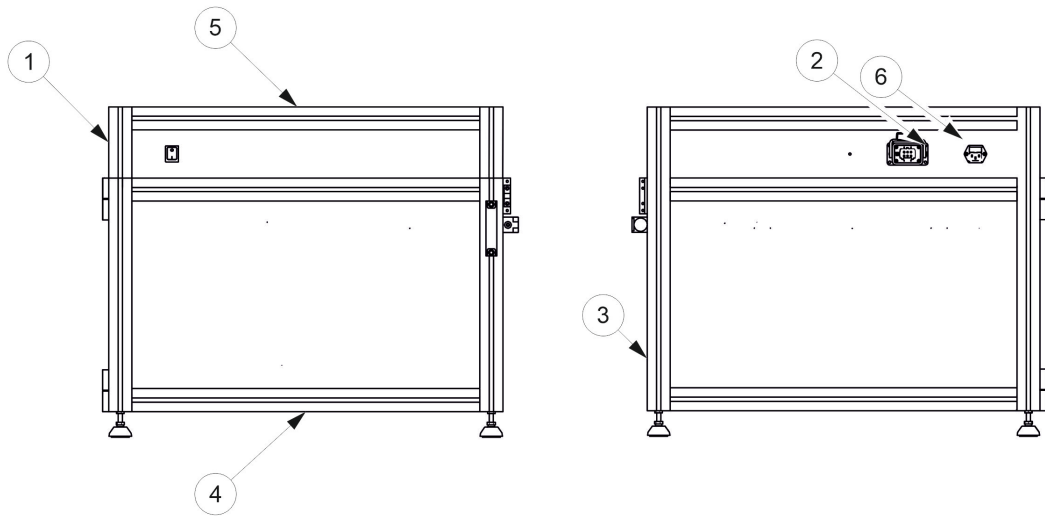

Pos.	Designation	Pos.	Designation
1	Irradiation chamber	2	Connector for UV-MAT
3	Cable feedthrough	4	Air inlet for samples
5	Air outlets	6	Mains connector



(1)

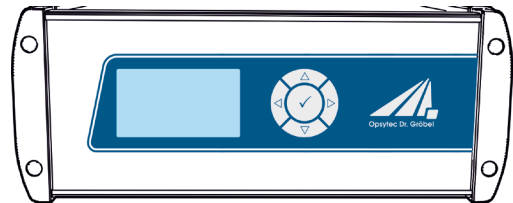

(2)

Pos.	Designation	Pos.	Designation
1	UV-Mat Touch	2	UV-Mat

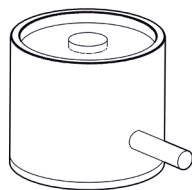

(1)

Pos.	Designation	Pos.	Designation
1	Sensor		

The UV-MAT unit contains the power supply, the microcontroller system with display and keyboard and the output controls. The sensor is connected to the backside of the UV-MAT unit.

The sensors are adapted to the lamps, meaning UVA+ sensor for UVA lamps for example. The sensors are cosine corrected. Due to the excellent cosine correction it is possible to measure from a side position.

**The following components are delivered:**

- Irradiation chamber
- UV-Mat / UV-Mat Touch
- Sensor / sensors
- Power line cable
- This documentation
- Optional:
  - inert box
  - Lamps
  - Attenuators
  - PC interface / programming interface / USB
  - Connecting cable for the communication



For a simple description, the above-mentioned components are collectively referred to as system.

**The following components are required by the customer:**

- none

## 9 Commissioning

- Unpack all components and remove the packaging materials.

	<b>WARNING</b>
<b>Risk of injury! High Weight!</b>	
Always carry the system with two persons.	

- The irradiation chamber is delivered with UV lamps not mounted. You must install these. The irradiation chamber has two lamp groups (even and odd lamps). Always alternate the lamps when using two different types.
- Open the front door and insert the lamps into the lamp sockets. This is done by rotating the lamp 90°. Observe the grouping of the lamps when doing this.

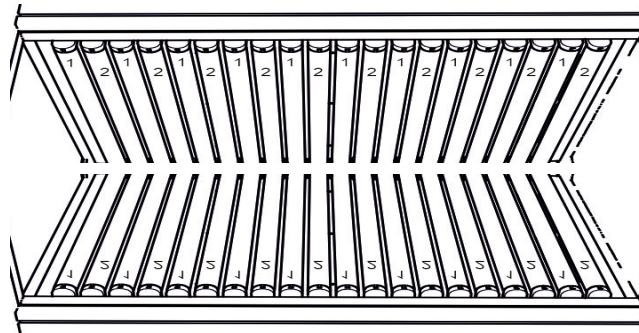

- Connect the UV-MAT to the irradiation chamber

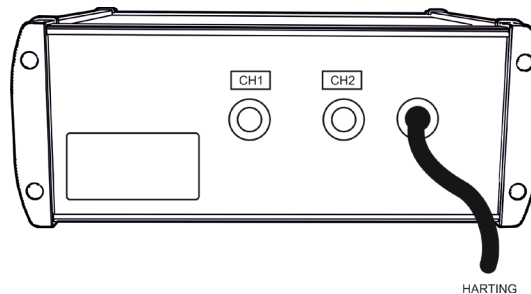



HARTING

(Image similar)

- Connect the sensor(s):
  - Mount the sensor(s) in the left-hand sensor holder inside the irradiation chamber.
  - Remove sensor caps.
  - Route the sensor cable through cable feedthrough in the rear side of the irradiation chamber.
- Connect the sensor with the UV-MAT. Pay attention to the assignment of the sensors.
  - The sensor connected to channel 1 controls lamp group 1.
  - The sensor connected to channel 2 controls lamp group 2.
  - If there is only one lamp group, connect the sensor to channel 1.

- Connect the irradiation chamber with mains voltage.
- Switch on the system by means of the switch on the front of the chamber.
- irradiation chamber is commonly completely operated by UV-MAT.

 <b>WARNING</b>	
	<p><b>Risk of damage</b></p> <p>To prevent thermal overheating, sufficient ventilation must be ensured at all times.</p> <p>Take special care that the ventilation openings are not covered during operation and that sufficient cooling is ensured.</p>

## 9.1 Installing and replacing a lamp

The useful life of UV amalgam low pressure lamps depends on the system design and the mode of operation (ON-OFF switching cycles, cooling, and pollution).

Frequent switching the irradiation chamber on / off can lead to a significantly reduced useful lifetime.

The lamps must be replaced if they no longer ignite or if the desired irradiance is no achieved. Dispose of the lamps properly. They do not belong in the residual waste.

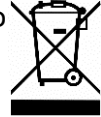

	<b>⚠ WARNING</b>
	<p><b>Risk of injury when touching live parts.</b></p> <p>Before opening the irradiation chamber, disconnect all components from the supply voltage and check that no voltage is present.</p>

**Lamp replacement is to be performed on the irradiation chamber via the front door. Proceed as follows:**

- Disconnect the irradiation chamber from the mains and check that no voltage is present.
- Open the front door and remove the lamps from the lamp sockets. This is done by turning the lamp 90°.

	<b>⚠ CAUTION</b>
	<p><b>Risk of damage</b></p> <p><b>Skin grease and dirt are absorbent in the UV and visible spectral range.</b></p> <ul style="list-style-type: none"> <li>• Avoid fingerprints on the optical components, sensor surfaces, lamps and reflectors. If necessary, clean the components carefully with isopropanol.</li> </ul>

- Insert the new lamps. When doing so, replace the lamps only with new lamps of the same type. Always insert the lamps alternately if you are using two different lamp types.
- Commonly your irradiation chamber is equipped with 2-channel UVMAT. If so, please make sure, that the lamps are in the right position. Install one lamp type into every second lamp holder. Mixing or reversing the lamps result in a different spectrum.
  - Lamp group 1: the first lamp seen from the front and every second
  - Lamp group 2: the second lamp seen from the front and every second

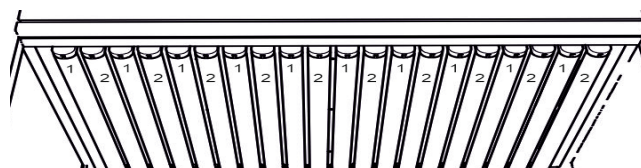

- When replacing the lamps completely, it is advisable to first remove all the lamps and then replace them.
- Reconnect the irradiation chamber to the supply voltage.

## 9.2 Attenuator\*

Two types of attenuators are available:

1. lamp attenuators\* that are slid over the lamps (1).
2. an area attenuator\* that is slid under the lamps (2).

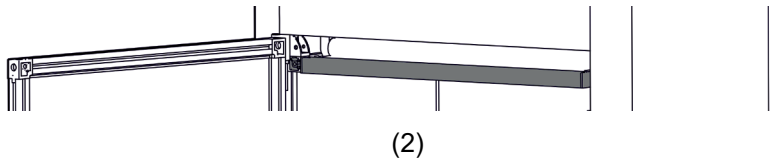
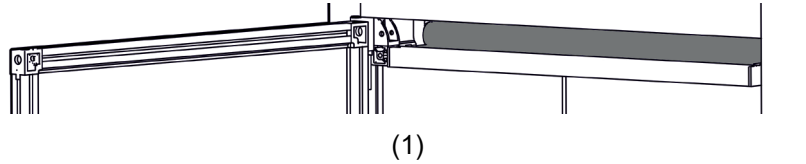

### 9.3 Commissioning and Use of inter box\*

#### If your chamber is equipped with an inert box:

Unpack inert box and clean front window with ISOPROPANOL alcohol.

Air-inlet and air-outlet can be changed depending on customer needs.

Pull the connecting hoses for the N2 input and N2 output through the rear openings of the irradiation chamber.

Attach the connecting hoses to the inert box.

Open the inert box with the four screws on the top and place the parts to be irradiated in the inert box.

Place the inert box in the irradiation chamber. Flush inert box until output gas oxygen concentration is below required limit. As an alternative: Flush inert box for several minutes.

Irradiate!

After irradiation, proceed in reverse order.

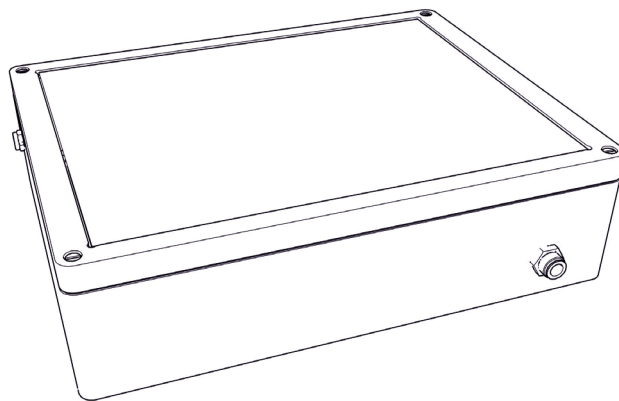

(Image similar)

	<b>⚠ WARNING</b>
	<b>Risk of injury!</b> Do not evacuate the inter box. Inert box is not made for evacuation.



## 10 Operating

The irradiation chamber is switched on together with the UV-MAT / UV-MAT TOUCH using the power switch on the front of the irradiation chamber.

	<b>⚠ CAUTION</b>
	Wear gloves when working in the BS-02 irradiation chamber.

	<b>⚠ CAUTION</b>
	<p>The equipment is equipped with UV lamps. There is a risk of photochemical damage to the eye, retinal damage and erythema. The operating personnel must be suitably trained.</p> <p>Do not open the door during irradiation. Close the front door immediately if the lamps are not switched off automatically.</p>

	<b>⚠ CAUTION</b>
	The front door is monitored. If it is opened during irradiation, the UV lamps are automatically switched off. Since this occurs with a slight delay, the user may be exposed to UV radiation for a short time.

### Summary:

Open the front door of the irradiation chamber and place the objects to be irradiated in the irradiation chamber.

Make sure that the built-in sensor is not covered for dose-controlled radiation.

Close the front door of the irradiation chamber, otherwise the UV lamps won't turn on.

Start the irradiation by main switch, timer, operation mode switch or UV-MAT, depending on your options. At the end of the exposure open the front door of the irradiation chamber and carefully remove the irradiated objects. Don't forget to switch off irradiation chamber.



If you only use lamps of the same type, it makes sense to set a lamp group. This way the dimming is done for all lamps together.

- Select the operating mode Dose or Time controlled.

- Set the desired dose or time. For this purpose, note the assignment of the sensors and the lamp group. If, for example, a UVA sensor is connected to channel 1, UVA lamps must also be inserted in lamp group 1.
- Start the irradiation by main switch, timer, operation mode switch or UV-MAT, depending on your options. At the end of the exposure open the front door of the irradiation chamber and carefully remove the irradiated objects. Don't forget to switch off irradiation chamber.



The signal lamps on the front of the irradiation system also show the status of the lamp groups.

## 11 Operation with a UV-Mat Touch

The UV-Mat Touch is characterized by its capacitive touch display and the extended functions compared to the UV-MAT. In addition, remote control via USB is possible.



As an alternative to the UV-MAT Touch, we offer the UV-MAT. This chapter only refers to the operation on the UV-MAT Touch.

The display can be operated with a finger. The display is not suitable for other objects, such as ballpoint pens.

The UV-MAT has two operating modes:

- Dose-controlled
- Time controlled (no sensor is needed)

The menu items in the main menu depend on the settings, i.e. the menu items "Dimming" and "Irradiation time" are only displayed if the respective mode has been selected.

### 11.1 Switch on / Switch off

After starting the device via the switch of the irradiation chamber, the logo and some information about the system first appear in the display.



After approx. 3 s, the main screen appears. This contains information about the settings of the individual lamp groups. Irradiation is started from here.





When the device is switched on for the first time, the date and time should be checked and set if necessary.

Turn off the system at the switch on the front panel.



The operating mode and the set power are saved permanently. After a restart, the last operating mode is selected (exception: settings).

## 11.2 Introduction to the user interface

The UV-MAT Touch has an intuitive user interface. All values relevant for the measurement are displayed in the center of the screen. The various menus Measurement screens are explained in the following chapter.

After switching on, the main screen appears. This contains information about the settings of the individual lamp groups. Irradiation is started from here.



The main screen contains information about the settings of the individual lamp groups. Irradiation is started from here.

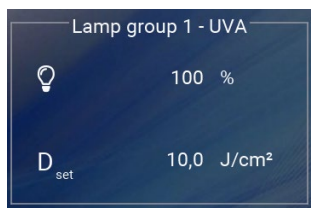

This area displays the current settings of the individual lamp groups.

Here in the example, both channels are independently dose controlled and the lamp intensity is 100% for both.



















It is possible to enter the settings menu of the respective lamp group by pressing the box with a finger.

Clicking on the menu symbol at the upper left edge opens the **main menu**. The menu closes either by clicking the [x] symbol, by clicking outside the menu or automatically after 5 s.



The different menus Measurement screens are explained in the following chapter.

Here the symbols mean:

Symbol	Function
	Menu
	Settings menu
	Start irradiation
	USB connection to a PC
	USB stick plugged
	Sensor temperature
	Sensor designation
	Sensor channel
	Sensor error
	Irradiation chamber door is closed
	Irradiation chamber door is open
	Display date & time
	Opens a numeric input window
	The lock icon appears when the GUI is locked to the condition.
	Measured value recording running / stopped
	The battery symbol indicates that the real-time battery of the device is exhausted.
	Cancel and return to the main menu
	Saves a screenshot

### 11.3 Setting the setpoints

Both groups of lamps can be adjusted independently of each other. There are essentially two setting options:

1. Dimming: 2-100%
2. Operating mode: time or dose controlled

#### 11.3.1 Dimming

The dimming of the individual lamp groups can be adjusted by pressing a button on the respective lamp group box in the main screen.

This keystroke takes you directly to the settings menu. Both lamp groups can be found under the menu item "Dimming". It is possible to set each lamp group separately or both to the same value. This can be done by pressing the button "Lamp group 1+2".

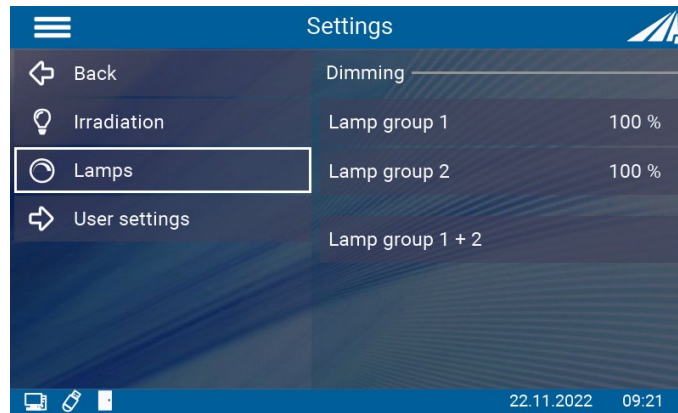

Clicking on one of the three fields opens a numeric block that can be used to set the power.

Minimum 2%: Lamp lights dimly

Maximum 100%: Lamp lights at full power

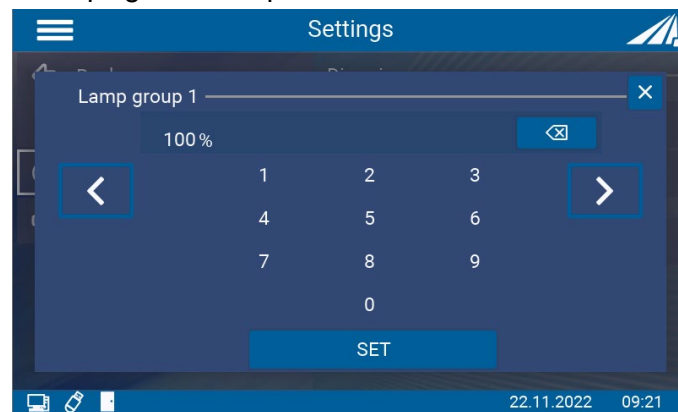

Current input

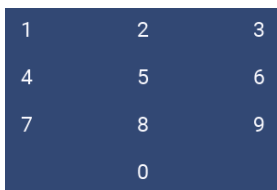

Numeric keypad via which the desired value is entered



Deletes the current input



The cursor can be moved left and right with the arrow keys. Alternatively, the desired cursor position can be selected by clicking in the input field



With OK the input is confirmed and saved



Closes the field without saving

### 11.3.2 Operating mode

There are two operating modes to control the lamp duty cycle. One is via the time and the other is via the dose. In dose-controlled mode, the irradiation is automatically stopped when the target dose is reached.

In time-controlled operation (timer), the irradiation time is controlled. Only the irradiation time is shown on the display. No sensor is required for time-controlled irradiation, so that the irradiation chamber can continue to be used, for example, during recalibration of the sensor.



In dose-controlled mode, irradiation is controlled automatically and stops when the desired dose is reached. Note that a sensor must be connected.



In timed mode, the irradiation time is controlled only by a timer. A sensor is not required.

The irradiation time can be selected individually for both channels.

This setting can be accessed by pressing the respective lamp group box in the main screen. Both operating modes can be found in the Irradiation menu item. The desired operating mode can be selected here by pressing a key.

#### 11.3.2.1 Dose operating mode

In dose-controlled mode, irradiation is automatically stopped when the target dose is reached.

In the Dose mode, a desired value can be set for each group, at which the lamp is to be switched off when reached.

It is also possible to select a value for both lamp groups together.

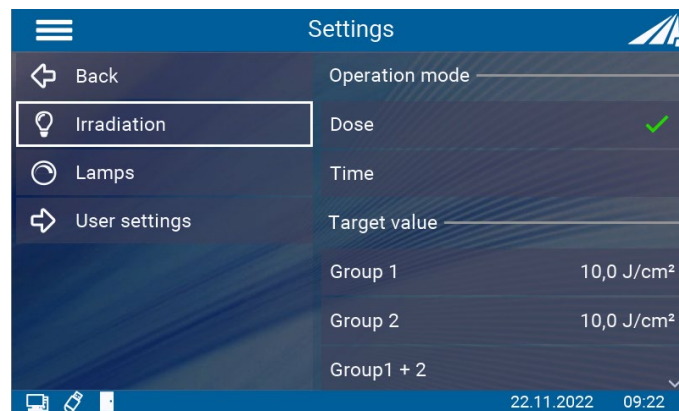

If you scroll down, you will find another setting option.

The channel control can be used to set which sensor should be active for which lamp group. It is also possible to activate one sensor for both lamp groups.

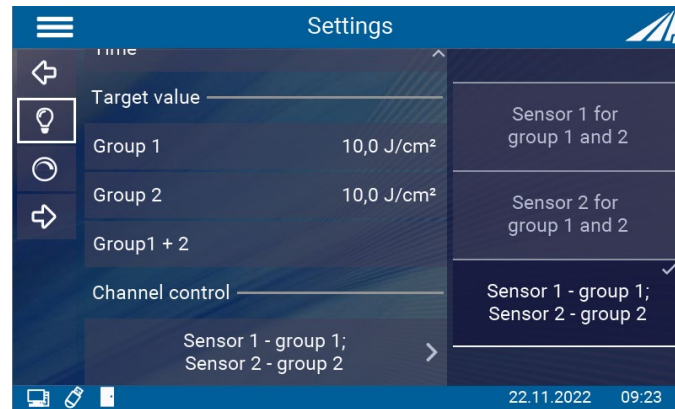

### 11.3.2.2 Time operating mode

In time-controlled mode, you can set the duration of irradiation for each channel:

To do this, select the "Time setting" menu item. If "Time setting" is not displayed, please first select "Time controlled" in the "Operating mode" menu.

In the time-controlled mode, the irradiation time is controlled only by a timer. The display shows the irradiation time and, if a sensor is connected, the irradiation intensity. A sensor is not required for the timer mode.

In the Time operating mode, an individual time can be set for each channel, after which the lamps are switched off.

It is also possible to select a value for both lamp groups together.

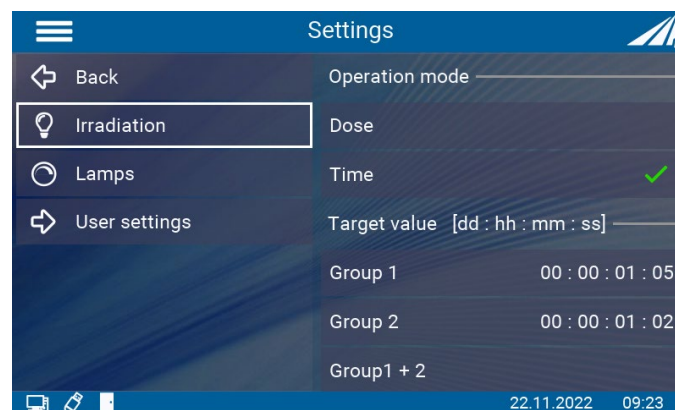

## 11.4 During irradiation

The UV-MAT Touch includes different measurement screens to cover the various measurement requirements. During irradiation, three different views can be selected. These are: Irradiation, Dimming and Scope. These are selectable via the tabs. Alternatively, the display can be changed by swiping to the right and left.

Here the symbols mean:



Displays the set dimming



Displays the plugged in sensor and the current irradiance



Displays the current dose



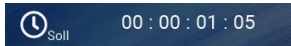

Displays the target time. After this time, the irradiation is terminated.



When a maximum dose is set, the target dose is set. When the dose is reached, the irradiation is terminated.



The progress bar shows the current progress

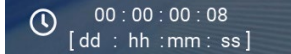

Displays the current irradiation time



Irradiation is canceled. The abort must be confirmed again.

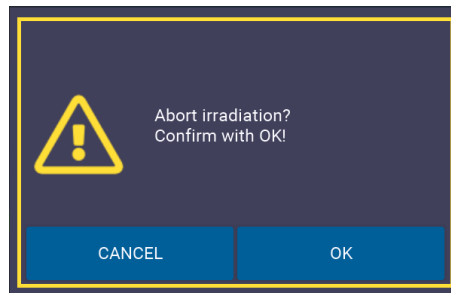

Radiation is paused. The pausing must be confirmed again.

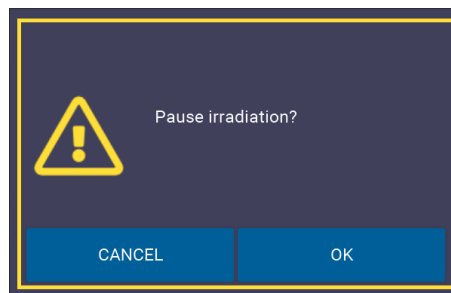

After the irradiation is paused, an orange frame appears around the display.

The lamps are switched off, the dose or time is paused, the door can now be opened.

If it is set that a sensor is activated for both lamp groups, it will only be displayed in the corresponding lamp group.

#### 11.4.1 Display irradiation

This display shows the various settings of the individual lamp groups. In this example, a time is specified after which the irradiation is ended. If a maximum dose is set, only the should and is display changes.

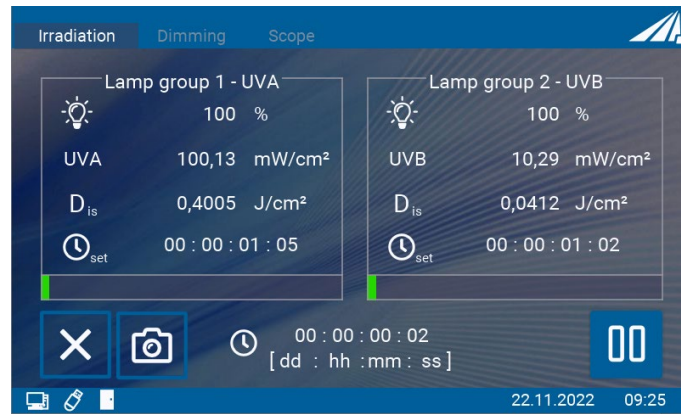

### 11.4.2 Dimming display

In the Dimming display, the individual lamp groups can be dimmed independently of each other. Adjustment in individual steps is possible with a single click. Quick adjustment by holding the button.

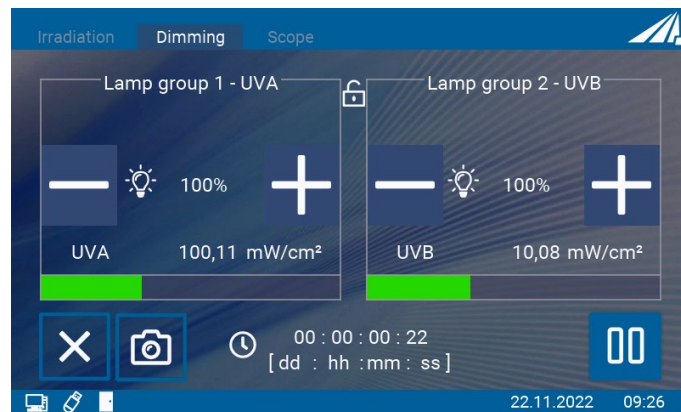

### 11.4.3 Scope display

This display is used to graphically show the progress of the irradiation.

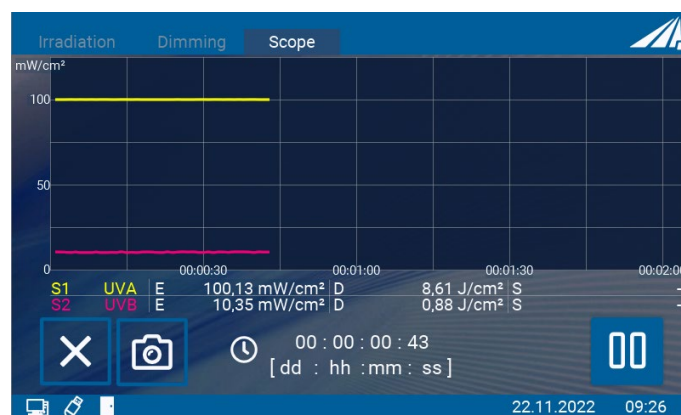

Here the symbols mean:



Display of the sensors and the assigned colors

### 11.5 After irradiation

The end of the irradiation is indicated by the full green progress bar and the display "FINISHED".

The current values can now be read off.

In addition, it is possible to restart the irradiation with the same settings or return to the main screen.



Back to the main screen



Start irradiation again with the same values

### 11.6 Data recording

Measurement data can either be recorded to a USB stick or output via USB.

The measurement data files are saved as CSV files. CSV stands for comma-separated-values. A CSV file stores tabular data (numbers and text) in plain text. CSV is a simple file format that is supported by many programs and can be opened with a spreadsheet such as Microsoft Excel or OpenOffice.org Calc.

In the following, the content of the lines is explained using a file excerpt:

```
RMD data file
www.opsytec.de
```

```
[RMD Info]
RMD Touch 5
Firmware1 .0.0518
Series N. 00101
Type 814405
Manu.Date11 .01.2021
```

Information about the measuring device used

```
[Measurement information]
Measurement modeTiming
time interval 60 s
Averaging 0.25s
File name 210413\130217.csv
Decimal separator , [comma]
```

The settings used during data recording.

```
[CH1 Info]
Sensor typelfach , LUX, RM-Digital
Sensor
```

Information about the sensors used.

```
Type                814461
Serial number        00135
Calibration date10   .05.2019
Unit                 klx
Wavelength range380 - 780 nm
Measuring range0-2000 klx
```

[CH2 Info]

```
Sensor type1x , UV-C, RM-Digital Sensor
Type                814410
Serial number        00115
Calibration date10   .05.2019
Unit                 W/cm2
Wavelength range200 - 280 nm
Measuring range0-2000 mW/cm2
```

\*\*\*File open\*\*\*01.01. 201909:42:28

\*\*\*\*\*Measurements \*\*\*\*\*

Date [DD.MM.YYYY]	Time [HH:MM:SS]	CH1: LUX [klx]	CH2: UVC [W/cm2]	Can
01.01. 201909:42:	280,	33900,	339022, 422,6	
01.01. 201909:43:	280,	3400,	679022, 522,6	
01.01. 201909:44:	280,	3401,	019022, 522,6	
01.01. 201909:45:	280,	33901,	358022, 422,6	
01.01. 201909:46:	280,	33901,	697022, 522,6	
01.01. 201909:47:	280,	33902,	036022, 522,6	
01.01. 201909:48:	280,	33902,	375022, 522,6	

\*\*\*File closed\*\*\* 01.01.201909 :49:27

## 11.7 User settings

The "User settings" area can be accessed via the cogwheel symbol or via the main menu. Various system settings can be made here.

### 11.7.1 Sensors and chamber factors

In the Sensors menu item, various settings can be made for the sensors.

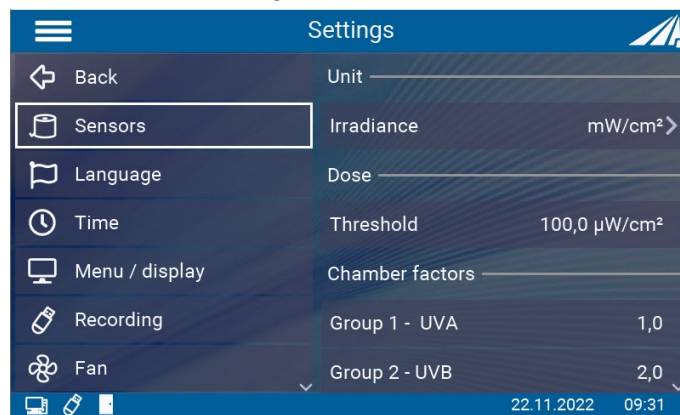

The unit of irradiance can be changed here.

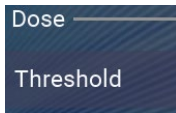

The irradiation dose is automatically summed up if it is higher than the threshold irradiance. This minimizes possible small offset errors.

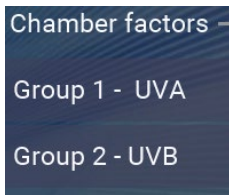

The chamber factor is used to calculate and output the irradiance at a different position (than the sensor position).



Further chamber factors (for unconnected) sensors can be seen here.

The chamber factor is used to calculate and output the irradiance at a different position (than at the sensor position). Thus, the displayed irradiance is the same even if measured at the lateral sensor position.

The chamber factor has already been determined and preset by the manufacturer. See the technical documentation in the appendix.



This setting should be tested for different specimen sizes / specimen heights. The initial setting was made centrally, approx. 35 mm above the specimen level (chamber bottom).

If you want to use the irradiance at any position, proceed as follows:

- Set as sensor factor: 1.0000
- Measure the irradiance at (any) position 1.
- Measure the irradiance at the sensor position.
- Divide the irradiance at position 1 by the irradiance at the sensor position. The result is the sensor factor.
- Set the sensor factor.



Use the key to add a digit.

- Repeat the setting if you use several sensors / lamp groups.

### 11.7.2 Language

This menu item allows switching the system language between German and English and switching the decimal separator used between comma and dot. Analogous to the decimal separator, the thousands separator also changes.

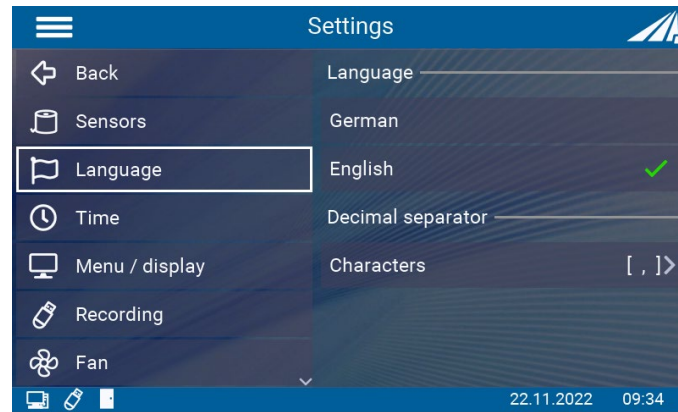

### 11.7.3 Time

The RMD Touch has a real-time clock. You can set the real-time clock in the "Date / Time" menu.

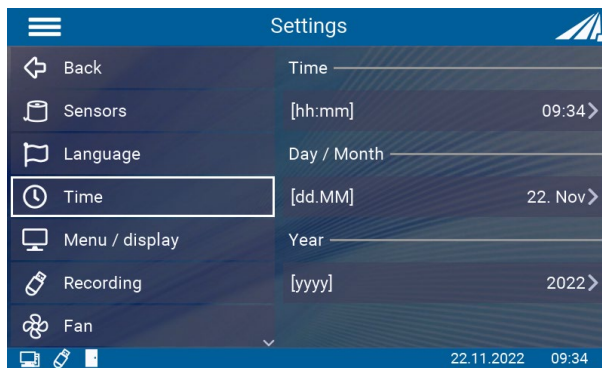

The real-time clock is set automatically by connecting the device to the PC software or can be set in the Time menu. Setting the time may be necessary e.g. after a firmware update or after resetting to factory settings.



#### Note

The real-time clock is supported by an internal battery for a short time. Leave the power cord plugged in to conserve the battery.

Check the settings after a leap day / leap second or after changing the summer/winter time.

### 11.7.4 Menu/Display

The screen brightness can be set here.

In addition, it is possible to choose a password to lock different areas of the settings menu.

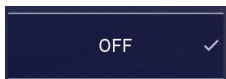
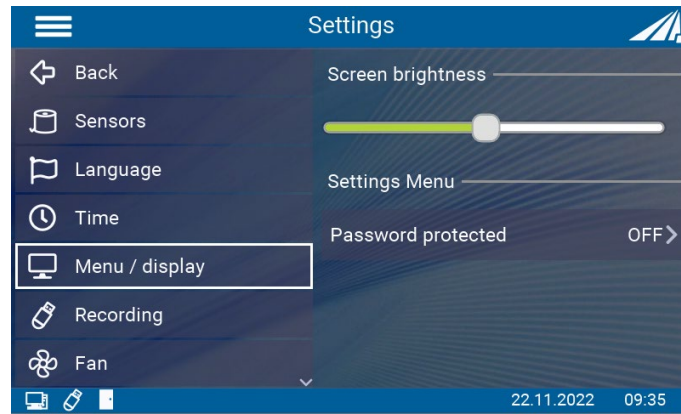

no password protection, all menus are active



All settings are password protected



only the "User menu" is password protected. Irradiation and dimming can be changed.

The password is: 7243

### 11.7.5 Record

The UV-Mat Touch can create a protocol of the irradiation. There are various setting options here.

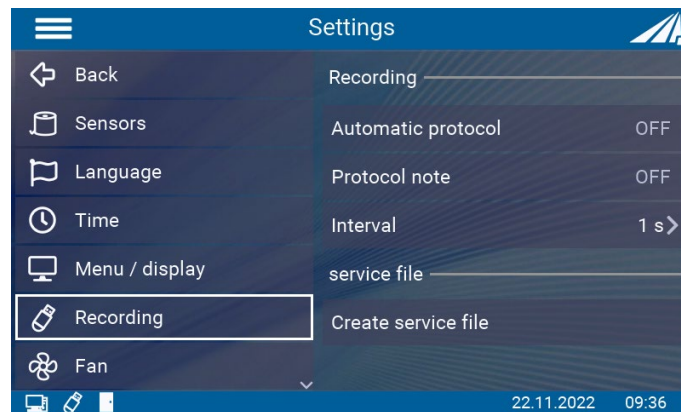

A protocol is created for each irradiation and saved on the USB stick



If on and automatic protocol is on, a note can be typed in before each irradiation



Measured values are saved at the set interval

A service file can also be created here, which supports troubleshooting by the manufacturer

### 11.7.6 Fan

It is possible to adjust the fan during and outside irradiation. Thus, the volume alone can be reduced.

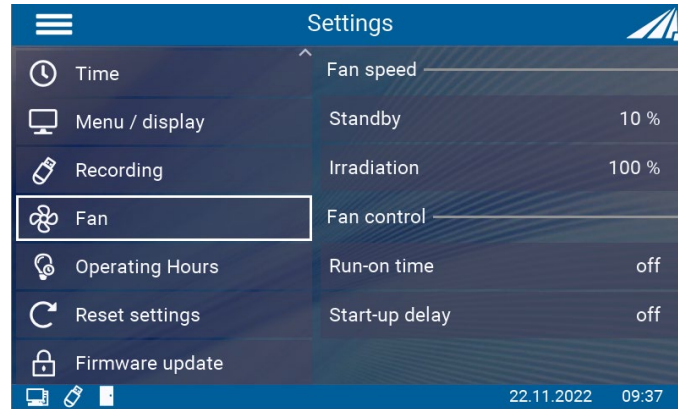

Standby	10 %
---------	------

Fan power in standby / without irradiation

Irradiation	100 %
-------------	-------

Fan power during irradiation

Run-on time	off
-------------	-----

The fan continues to run for the set time after irradiation with the irradiation power

Start-up delay	off
----------------	-----

The fan runs for the set time after the start of irradiation still with the standby power

### 11.7.7 Operating hours

In this menu item, the operating hours of the lamp can be reset. This is necessary when the lamps are replaced with new ones.

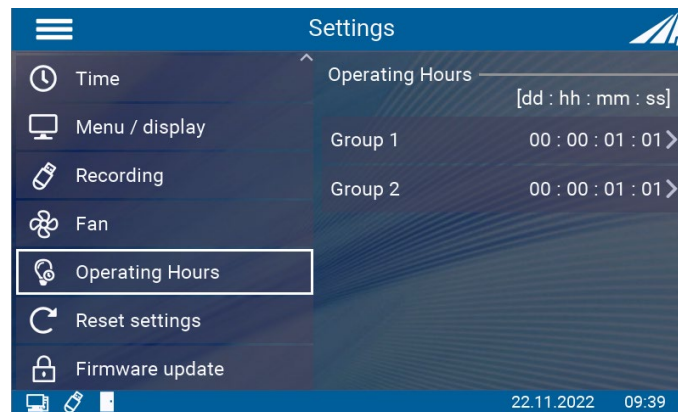

### 11.7.8 Reset

By confirming, the device is reset to its original settings and restarted. Afterwards, the time must be set again. The switch responds with a long click.



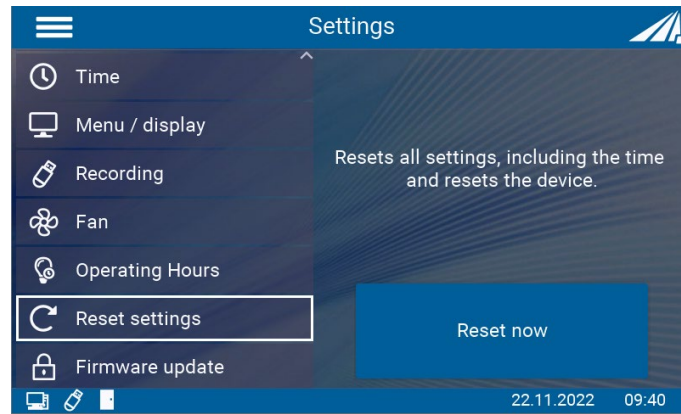

### 11.7.9 Firmware update

The firmware of the device can be updated with a Windows PC.

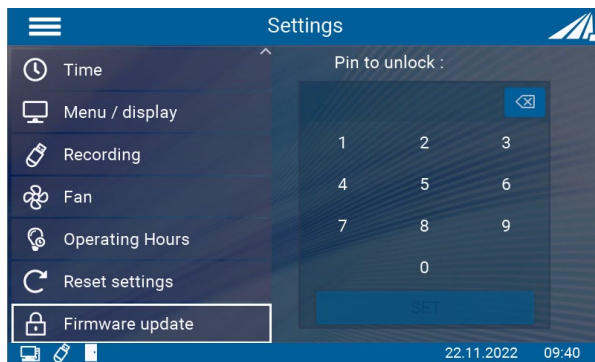

Please contact the manufacturer for this.

### 11.8 Information

Sensor-specific and device-specific information can be called up under the Information menu item. Only connected sensors are visible in the menu.

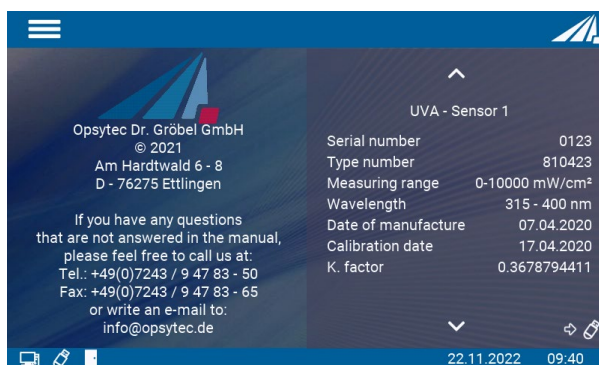

Display of sensor information. If no sensor is connected, this menu item is not displayed.



Display of information about the UV-MAT Touch.

## 11.9 Error messages

The system issues various error messages. It is possible to react to them in different ways.

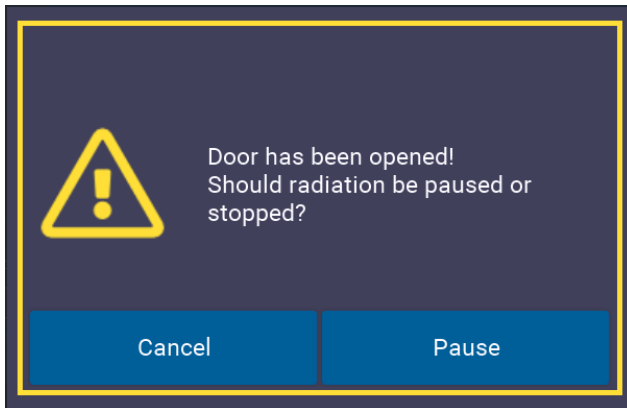

During irradiation, the door was opened.

Irradiation is automatically interrupted and the lamps are switched off.

Cancel: Irradiation is canceled and the control returns to the main screen.

Pause: Irradiation is paused and can be resumed with the door closed.



An attempt has been made to start irradiation even though the door is still open.

Previous: Control returns to the main menu

OK: Irradiation is started when door is closed.

## 12 UV-MAT operation



As an alternative to the UV-MAT, we offer the UV-MAT Touch. This chapter only refers to operation on the UV-MAT.

After starting the device, the logo first appears on the display. Then the device is in standby and the main menu is displayed. The menu items in the main menu depend on the settings. For example, the menu items "Power 0..100%" and "Irradiation time" are only displayed if the corresponding mode has been selected.

The UV-MAT is operated via five keys. These keys are arranged in the front, right next to the display. The keys and the function configuration are shown below:

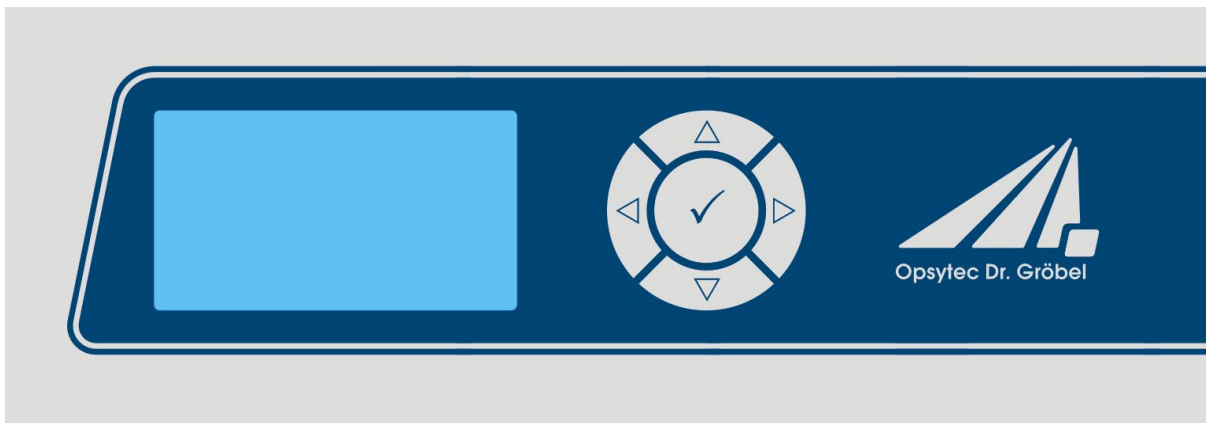

Key	Function
▽	Down
△	Up
◁	Left
▷	Right
✓	Confirm / OK

In the main menu and all other menus, select the active menu item via the keys ▽ and △. By clicking ✓ you confirm the selected menu item. With ◁ you return to the previous menu without adopting the changes.

The selected menu item is displayed on a black background and inverted.

UV-MAT offers three operation modes:

- Timer
- Dose controlles

The menu items in the main menu depend upon the settings, i.e. the menu items "Dimming" and "Irradiation time" are only displayed, when the respective mode has been selected.

## 12.1 Switching on

Switch on the control unit at the front switch. After starting the device, the logo appears on the display followed by a short self-test.



The device is then in standby and the menu is displayed.

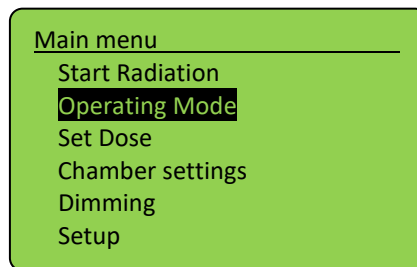

## 12.2 Switching off

Switch off the LED system at the front switch.



The operating mode and the set power are saved permanently.  
After a restart, the last operating mode is selected (exception: settings).

## Start / Stop Radiation

Start an irradiation by selecting “Start Radiation” and press ✓.

In time controlled operation mode the current irradiation time and end time are displayed in the form DD:HH:MM:SS.

In dose controlled operation mode the current irradiance in mW/cm<sup>2</sup>, the actual irradiation time, the current dose (Is:) and the target dose (Set:) are displayed:

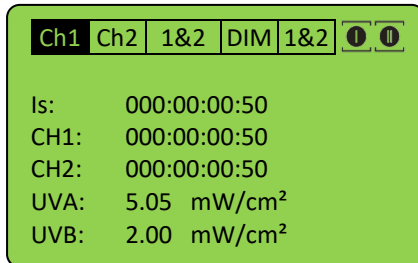

Time controlled

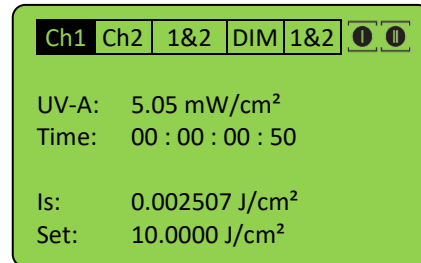

dose controlled



Use to ◀ and ▶ keys to switch channel screens.



mW/cm<sup>2</sup> and J/cm<sup>2</sup> are automatically calculated.



Dimming level can be changed during active irradiation with ▲ and ▼ keys. If CH1 or CH2 is selected then the corresponding lamp group is dimmed. In case of 1&2 or DIM both lamp groups are dimmed.

In the dimming screen the current lamp power is visible:

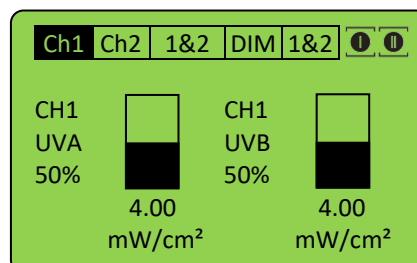

Stop an irradiation by pressing ✓ for at least 2 seconds.

### 12.2.1 Operation Mode

In dose-controlled mode, irradiation is automatically stopped when the target dose is reached. In time-controlled mode (timer), the irradiation time is controlled. Only the irradiation time is shown on the display. No sensor is required for time-controlled irradiation, so that the irradiation chamber can continue to be used, e.g., during recalibration of the sensor.

Select operating mode the select dose controlled or time controlled irradiation.

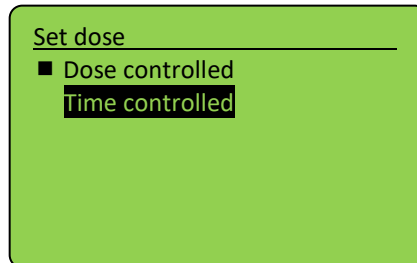

Confirm by with ✓ or ▷. With ◀ you can cancel your input and go back to main menu.



In dose controlled mode the irradiation time is automatically controlled and stops if the desired dose is reached. Note a sensor must be connected therefore.



In time controlled mode the irradiation time controlled by a timer only. On the display only the irradiation time is displayed. A sensor is not necessary.

The Irradiation time is selectable for both channels individually.

### 12.2.2 Timer mode

In the menu “Irradiation Time” you can set the irradiation time for the timer. Therefore select menu item “Set time”. If “Set time” is not displayed, please choose “Time controlled” in menu “Operation Mode” first.

The irradiation time can be set for CH1 and CH2 together or individually. Select the time you like to change.

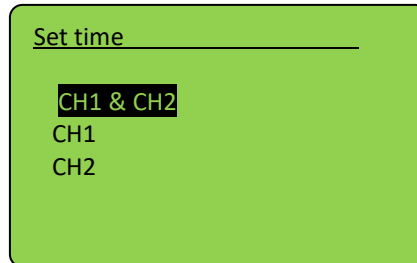

Now you can select the decimal with the keys ◀ or ▶ and with the keys ▲ or ▼ you can set the time to the desired value. Confirm with OK (✓) to return to the main menu.

In timer mode you can set the duration of irradiation:

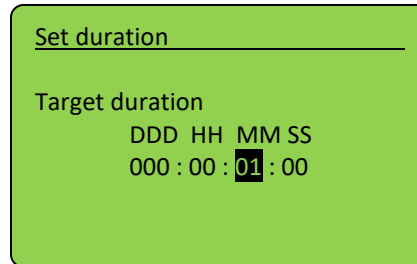

The maximum duration is 999 days, 23 hours, 59 minutes and 59 seconds.

The irradiation time can be set different for both channels.

With the keys ▼ and ▲ the power can be modified during the exposure.

In time controlled mode the irradiation time controlled by a timer only. On the display the irradiation time and, if a sensor is connected the irradiance, is displayed. A sensor is not necessary for timer mode.

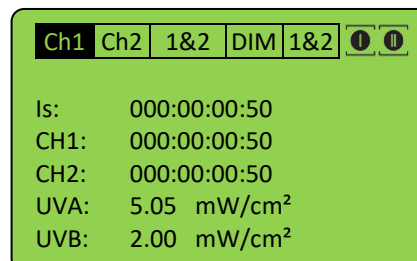



### 12.2.3 Dose controlled mode

Select operation mode dose controlled. Confirm by with ✓ or ▷. With ◀ you can cancel your input and go back to main menu.



In dose controlled mode the irradiation time is automatically controlled and stops if the desired dose is reached. Note a sensor must be connected therefore.

Set the target dose for an irradiation in the menu “Set dose” and select the channel / sensors first:

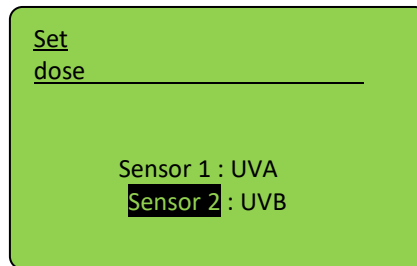

Now, select the dose:

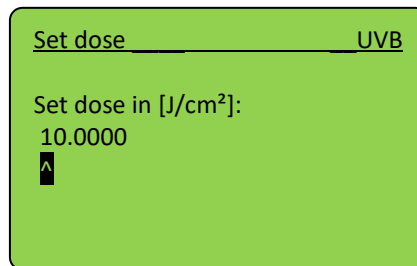

Use the ◀ key to add a digit.

Use △ and ▽ keys to change value and confirm with ✓.

Return to main menu and start an irradiation by selecting “Start Radiation”.

In dose controlled operation mode the current irradiance in mW/cm<sup>2</sup>, the actual irradiation time, the current dose (Is:) and the target dose (Set:) are displayed:

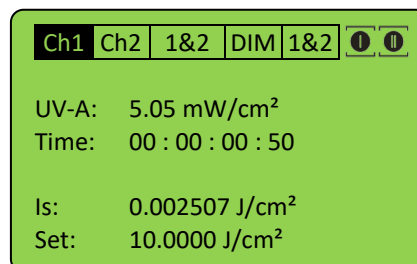



mW/cm<sup>2</sup> and J/cm<sup>2</sup> are automatically calculated.

Stop an irradiation by pressing ✓ for at least 2 seconds.

### 12.3 Settings menu

Using this menu you can set the system settings.

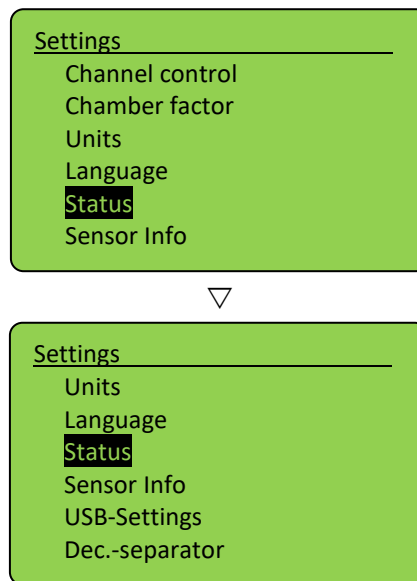

#### 12.3.1 Channel control

The system has two lamp groups (even and odd numbered lamps). Always use the lamps alternately when using two different types. Use channel control to select mode

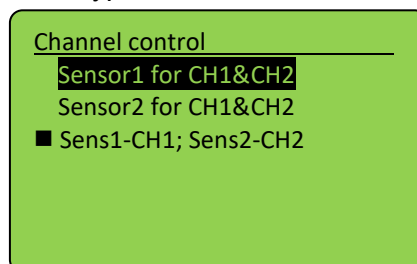

##### **Sensor1 for CH1&CH2:**

All lamp groups controlled by the dose set for sensor connected to input Sensor 1

##### **Sensor2 for CH1&CH2:**

All lamp groups controlled by the dose set for sensor connected to input Sensor 2

##### **Sens1-CH1; Sens2-CH2:**

Odd-numbered lamps controlled by Sensor 1, even-numbered lamps controlled by Sensor 2. The lamp groups are controlled by each sensor using this mode. This setting makes sense, while other setting may be for special applications.

Note, that the channel control is displayed during irradiation in the upper right corner. Here the icons have e.g. the following meaning:

 CH1 and CH2 are **ON** and controlled separately

 CH1 and CH2 are **OFF** and controlled separately

 CH1 and CH2 on and controlled by Sensor 1

 CH1 and CH2 on and controlled by Sensor 2



The signal lamps on the front of the irradiation system also show the status of the lamp groups.

### 12.3.2 Chamber factor

In this submenu the sensor specific adjustments are placed. It is possible to do the sensor calibration and set the upper and lower limits. In all three submenu points you have to decide first for which sensor port you want to do the adjustment, if Your UV-Mat version is capable of more than one sensor.

The sensor factor is used to calculate and output the irradiance at a different position (than at the sensor position). This means that the irradiance displayed is the same even when measuring at the lateral sensor position.

The sensor factor has already been determined and preset by the manufacturer. See the technical documentation in the appendix.



This setting should be checked for different sample sizes / sample heights. The initial setting was made in the middle, approx. 35 mm above the sample level (chamber bottom).

Example:

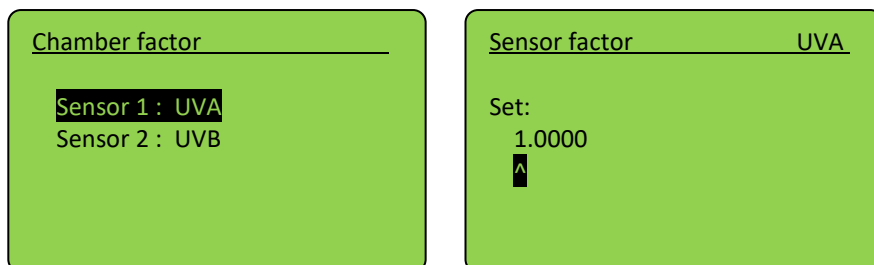

If you want to use the irradiance at any position, proceed as follows:

- Set the sensor factor to: 1.0000
- Measure the irradiance at (any) position 1.
- Measure the irradiance at the sensor position.
- Divide the irradiance at position 1 by the irradiance at the sensor position. The result is the sensor factor.
- Adjust the sensor factor.
- Repeat the setting if you use several sensors / lamp groups.



Use the button ◀ to add a digit.

Navigate with ◀, ▶ and set value with ▲, ▼. Confirm with ✓ to go back to setup menu.

### 12.3.3 Units

Unit in which the measured values of the sensors are displayed. This is a setting for the sensor that applies to the measured channel (including dose).

Irradiance

- $\text{mW/cm}^2 \Rightarrow \text{mJ/cm}^2$
- $\text{W/m}^2 \Rightarrow \text{J/m}^2$
- $\mu\text{W/cm}^2 \Rightarrow \mu\text{J/cm}^2$

### 12.3.4 Setting the menu language

The menu languages German and English are available. The setting is taken out in the menu "Settings", then click on "Language".

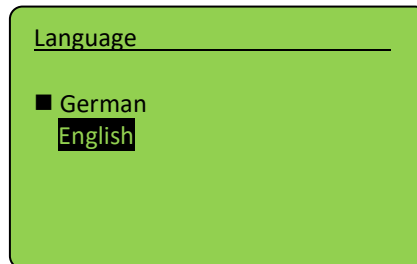

Select the desired language with the keys  $\nabla$  and  $\triangle$  and confirm with  $\checkmark$ .

### 12.3.5 Status

Here status information is given:

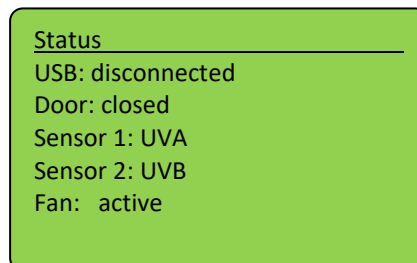

Back with  $\triangleleft$ .

### 12.3.6 Sensor Info

Sensor-specific information can be called up under the menu item. Only connected sensors appear in the info menu.

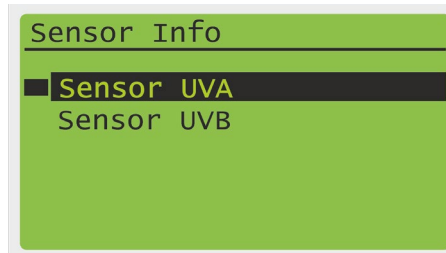

Display information about the sensor. If no sensor is connected, this menu item is not displayed.

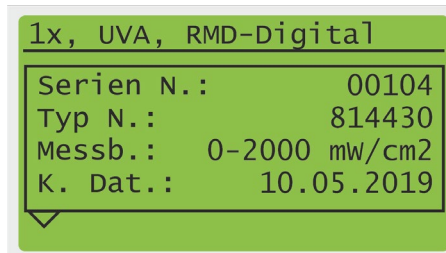

### 12.3.7 USB-Settings

This menu item enables or disables USB output and control:

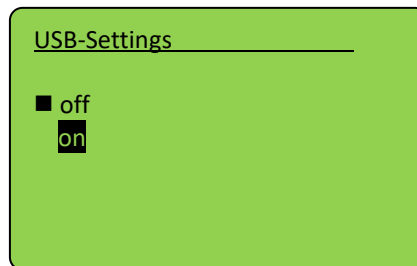

You are requested to set the send time. This is the time interval between automatic status information.

### 12.3.8 Dec.-separator

This menu item changes decimal separator for USB output:

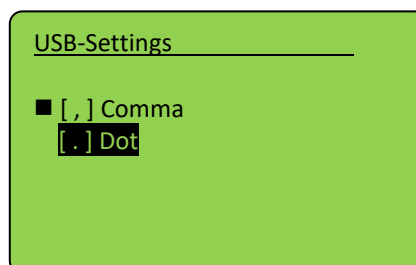

## 12.4 Dimming menu

You can change the dimming setting in the main menu via the Dimming menu item. It is possible to set a dimming value between 10% and 100% individually for each lamp group.

Note: The dose control on the UV-MAT does not fall back on the dimming setting, but ends the irradiation at the dose reached.

First select the lamp group in the Dimming menu.

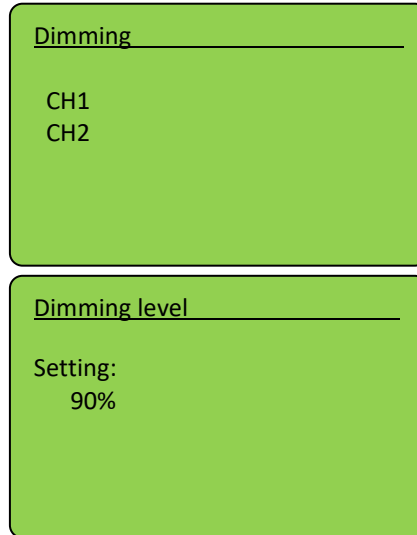

Use  $\triangle$  and  $\nabla$  keys to set desired value. Confirm with  $\checkmark$ .



Dimming level can be changed during active irradiation with  $\triangle$  and  $\nabla$  keys.

## 12.5 Internal settings

Using this menu you can set the system settings. Therefore enter the PIN code, see *chapter technical data*, must be entered.

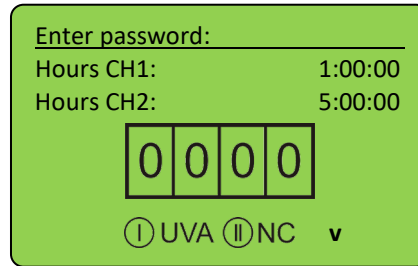

On this screen you will see the operation hours for each channel. The format is hours:minutes:seconds.

Even without PIN the operational hours, connected sensors and firmware version are displayed. After entering PIN and confirmation with OK you can change system settings:

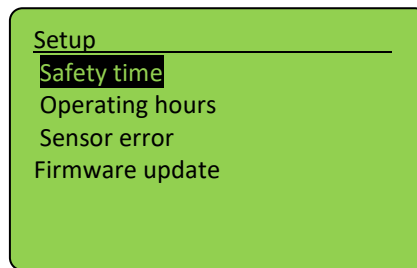

These are stored in this submenu for each spectral range. For this purpose, the spectral range is selected first and then the setting is made.

### 12.5.1 Safety time

Timing values can be adjusted in menu "safety time". See delay time, max. time and waiting time.

#### Delay time

The delay time is the time, which the UV-AB-Mat waits until it starts to monitor the sensor signal. It should be as long as the lamps need to get on a constant irradiance delivery.

#### Max. time

Max. time is a safety function. After reaching this time the irradiation is stopped. This value should be programmed carefully, because it can be very important e.g. sunburn through a wrong input of the dose can be prevented.

#### Waiting time

The waiting time is the time after the irradiation which must be waited to start a new irradiation. This time should be so long, that double irradiation is to be excluded. It should be set at least to **3 seconds** to prevent immediate user restart.



### 12.5.2 Operating hours

The user may reset the lamps operating hours using the menu item. Reset must be confirmed by pressing ▷.



Note that the displayed operating hours are only stored if an irradiation is stopped by UV-MAT. If the UV-MAT / irradiation chamber is switched off during irradiation the operating hours aren't stored and so faulty.

### 12.5.3 Sensor errors

Setting to select if sensor errors abort the irradiation or not.

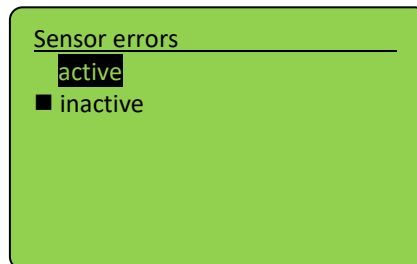

### 12.5.4 1.5.4 Upper and lower limit of each spectral range\*

Irradiance is automatically monitored during dose-controlled irradiations and irradiation is terminated when specified irradiance levels are exceeded or not reached. For example:

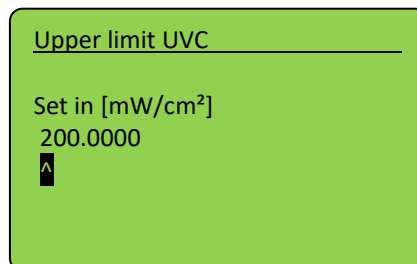

To determine the limits set the upper limit to 200 mW/cm<sup>2</sup> and the lower limit to 0 mW/cm<sup>2</sup>.

In this case, no error can occur (if the calibration factor is set to 1,000). Note the irradiance achieved after a sufficient warm-up time of approx. 30 minutes. It is recommended to set the upper and lower limit e.g. to ±25% of the sensor value.

Strong fluctuations in the measured values subside as the lamps warm up. Due to the safety times, irradiations are not interrupted during this time.

## 13 USB logging\* and REMOTE operation\*.

The UV-MAT automatically transmits all data when USB is set to active. The communication takes place as ASCII communication.



Communication is available after initialization.

Depending on the version, initialization may take a few seconds.

### Definitions:

- Baud rate: 115200 baud
- Parity: None
- Data-Bits: 8
- Stop-Bit: 1

With the USB Active setting, the UV-MAT sends status information at regular intervals, e.g. every second. The following software gives an example of the data acquisition functions:

The top screenshot shows the 'COM Log - Version 1.4' interface. The 'Settings' panel on the left is configured with Port Name: COM3, Baud Rate: 115200, Data Bits: 8, Parity: None, and Stop Bits: One. The 'Communication protocol' window displays the following information:

```

28.08.2020 14:53:06 [P*START]Start of measurement:
Dose controlled

Sensor 1:
UVA+
Serial Number: 00121
Typ Number: 814445
Calib. date: 03.12.2019
Calib. factor: 0.00204
Calib. unit: mW/cm2
Amplifiers f.: 101.0
amp. up limit(S.L.Op2): 28.08.2020 14:53:06 0.9
amp. down limit(S.L.Op1): 0.007
Wavelength range: 330nm-455nm
Offset 1: 0.007
28.08.2020 14:53:06 Offset 2: 0
Manu.Date: 02.04.2019
MemoryNR.: 1
OpHours: 22 h
OpH. Kalib: 22 h
OpH. Meas.: 20 h
28.08.2020 14:53:06 Max. Temp.: 32.0 C
Min. Temp.: 20.2 C

Sensor 2:

```

The bottom screenshot shows the same interface with the 'Communication protocol' window displaying a table of data acquisition results:

```

Target dose:
Sensor1: 0,1000 [mW/cm2]
Sensor2: 0,0500 [mW/cm2]
Channel control: Sensor1 controls CH1&CH2
Decimal separator: [.]
USB sending interval [sec]: 1

DDD:HH:MM:SS  Sensor 1  Power CH1 [%]  Irradiance [mW/cm2]  Dose [J/cm2]  Sensor 2  Power CH2 [%]
Irradiance [mW/cm2]  Dose [J/cm2]
28.08.2020 14:53:06 000:00:00:00 UVA+ 99  0,00 0,0000  UVA  5  0,00 0,0000
28.08.2020 14:53:08 000:00:00:01 UVA+ 99  0,84 0,0004  UVA  5  1,33 0,0007
28.08.2020 14:53:09 000:00:00:02 UVA+ 99  1,47 0,0019  UVA  5  2,41 0,0031
28.08.2020 14:53:10 000:00:00:03 UVA+ 99  1,46 0,0034  UVA  5  2,41 0,0055
28.08.2020 14:53:11 000:00:00:04 UVA+ 99  1,46 0,0048  UVA  5  2,40 0,0079
28.08.2020 14:53:12 000:00:00:05 UVA+ 99  1,45 0,0063  UVA  5  2,39 0,0103
28.08.2020 14:53:13 000:00:00:06 UVA+ 99  1,45 0,0077  UVA  5  2,40 0,0127
28.08.2020 14:53:14 000:00:00:07 UVA+ 99  1,45 0,0092  UVA  5  2,39 0,0151
28.08.2020 14:53:15 000:00:00:08 UVA+ 99  1,46 0,0107  UVA  5  2,40 0,0175
28.08.2020 14:53:16 000:00:00:09 UVA+ 99  1,46 0,0121  UVA  5  2,40 0,0199
28.08.2020 14:53:17 000:00:00:10 UVA+ 99  1,46 0,0136  UVA  5  2,40 0,0223
28.08.2020 14:53:18 000:00:00:11 UVA+ 99  1,46 0,0150  UVA  5  2,40 0,0247
28.08.2020 14:53:19 000:00:00:12 UVA+ 99  1,46 0,0165  UVA  5  2,40 0,0271
28.08.2020 14:53:20 000:00:00:13 UVA+ 99  1,46 0,0179  UVA  5  2,40 0,0295
28.08.2020 14:53:21 000:00:00:14 UVA+ 99  1,46 0,0194  UVA  5  2,41 0,0319
28.08.2020 14:53:22 000:00:00:15 UVA+ 99  1,46 0,0209  UVA  5  2,41 0,0343

```

Remote operation is required if the UV-MAT and the irradiation chamber are to be controlled via a USB interface. Remote operation is selected in the UV-MAT settings. In remote mode, operation on the device is not possible.



Remote operation is selected in the UV-MAT settings.

After successful initialization, remote operation is displayed as follows:



### 13.1 Software Installation

**For the installation, please proceed as follows:**

- 1.) If necessary, disconnect the connection of the UV-MAT with the PC.
- 2.) Start the installation with "setup.exe" in the master data of the Software CD. Follow the instructions of the installation program.



The driver installation is executed automatically as virtual COM port.

- 3.) After completing the installation, connect the UV-MAT with the PC. The UV-MAT is integrated as a virtual, serial interface. The driver installation is taken out automatically under Windows 7.

### 13.2 Connecting with the PC

Connect the UV-MAT with the PC and switch it on. The screen displays the message "REMOTE".

Once the UV-MAT is connected with the PC, it does not react to any keystroke. Disconnect the connection with the PC and the UV-MAT continues working autonomously.

## 14 Software – UV-MAT Control for UV-MAT Touch\*

The software "UV-MAT Control" is used to control the irradiation chamber with UV-MAT TOUCH by PC. The software makes it possible:

- Switching lamp channels on and off
- Change the power (of the lamp channels)
- To use a timer for the lamp channels
- To use one dose for the lamp channels

The software is divided into several sections. At the bottom of the software is a status bar with various notes.

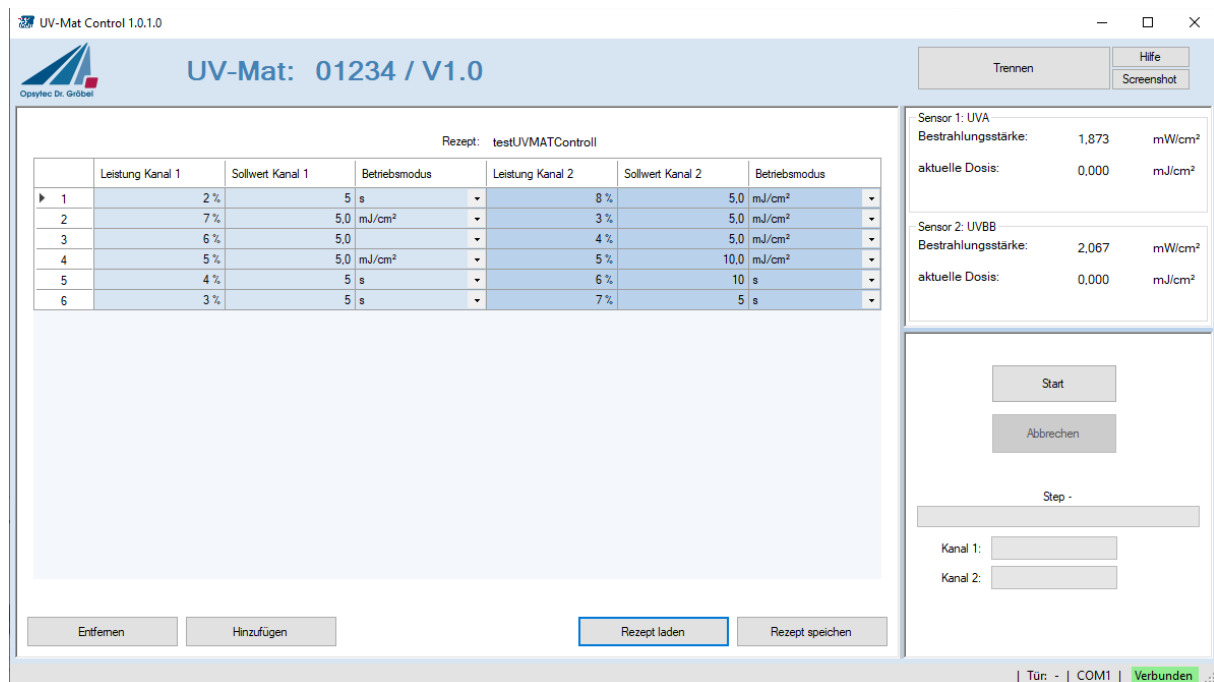

The functions are described below:

### Above

UV-Mat: 01234 / V1.0

Shows the serial number of the connected UV-MAT

Trennen

Connects or disconnects the UV-MAT from the PC and displays the connection status:

- Connected → separates the connection to the UV-MAT
- Not connected → connects the UV-MAT

Screenshot

Creates / saves a screenshot to document the irradiation

Hilfe

For further information

### Device control

The left area of the software is for control and monitoring. Here an overview table with all services, times and dose values for the channels is displayed.

Rezept: testUVMATControl

	Leistung Kanal 1	Sollwert Kanal 1	Betriebsmodus	Leistung Kanal 2	Sollwert Kanal 2	Betriebsmodus
▶ 1	2 %	5 s	▼	8 %	5,0 mJ/cm <sup>2</sup>	▼
2	7 %	5,0 mJ/cm <sup>2</sup>	▼	3 %	5,0 mJ/cm <sup>2</sup>	▼
3	6 %	5,0 mJ/cm <sup>2</sup>	▼	4 %	5,0 mJ/cm <sup>2</sup>	▼
4	5 %	5,0 mJ/cm <sup>2</sup>	▼	5 %	10,0 mJ/cm <sup>2</sup>	▼
5	4 %	5 s	▼	6 %	10 s	▼
6	3 %	5 s	▼	7 %	5 s	▼

The table is used to select the channels, to display the currently set power intensity and to display the channel status.

From the right-hand side there are various control functions for the irradiation together with the Start/Cancel button.

Sensor 1: UVA

Bestrahlungsstärke: 0,369 mW/cm<sup>2</sup>

aktuelle Dosis: 1,930 mJ/cm<sup>2</sup>

Sensor 2: UVBB

Bestrahlungsstärke: 1,029 mW/cm<sup>2</sup>

aktuelle Dosis: 3,742 mJ/cm<sup>2</sup>

Start

Abbrechen

Step 1 / 6

Kanal 1:  Zeit

Kanal 2:  Dosis

The progress of the process is displayed in the table:

	Leistung Kanal 1	Sollwert Kanal 1	Betriebsmodus	Leistung Kanal 2	Sollwert Kanal 2	Betriebsmodus
▶ 1	2 %	5 s	▼	8 %	5,0 mJ/cm <sup>2</sup>	▼
2	7 %	5,0 mJ/cm <sup>2</sup>	▼	3 %	5,0 mJ/cm <sup>2</sup>	▼
3	6 %	5,0 mJ/cm <sup>2</sup>	▼	4 %	5,0 mJ/cm <sup>2</sup>	▼
4	5 %	5,0 mJ/cm <sup>2</sup>	▼	5 %	10,0 mJ/cm <sup>2</sup>	▼
5	4 %	5 s	▼	6 %	10 s	▼
6	3 %	5 s	▼	7 %	5 s	▼

The process step is defined in the table. Example:

Channel 1 2% power for 5 s, channel 2 8% power for a dose of 5 mJ/cm<sup>2</sup>

### Software taskbar

At the bottom of the software is a bar with various functions: The right part of the bar is used to display errors and messages

Errors and messages appear in the display for 3 s, errors are highlighted in red. The last ten messages are displayed here while the mouse pointer is resting.

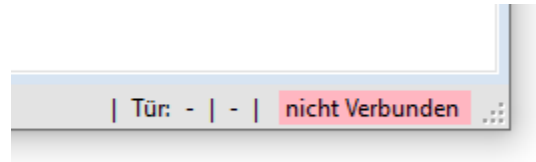

The left area is for displaying traffic jam messages

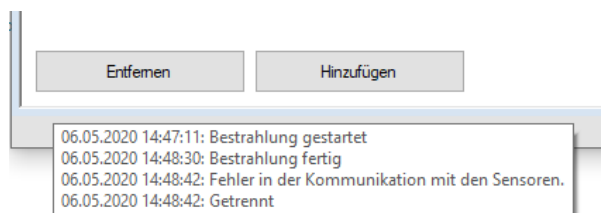

## 14.1 Working with the software

Make sure that the UV-MAT is connected to the PC and the BS-02 is switched on. Please note that the UV-MAT must be in remote mode so that the display shows REMOTE.



Remote operation is selected by the switch on the back.

**The switch must be active when starting the UV-MAT.**

When the software is opened, one of the UV-Mats connects automatically.

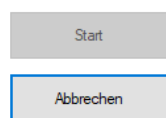

Press Start to start the irradiation with the set sequence.

Press Cancel to cancel the irradiation with the set sequence.

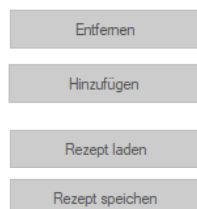

Here steps can be removed by marking a line or new steps can be inserted.

Here preset "Preset" / "Recipes" can be loaded and saved

### Presets:

Presets are saved as \*.csv files and can be viewed in an editor if necessary. Example:

```
testUVMATControll.csv
```

```
Date (dd.mm.yyyy); 29.48.2020
```

```
Software version number; 1.0.0.0
```

```
Number of Steps; 6
```

```
*****
```

```
power channel 1; setpoint channel 1; operating mode 1; power channel  
2; setpoint channel 2; operating mode 2;
```

```
*****
```

```
2;5;s;8;5;mJ/cm2;
```

```
3;5;s;7;5;s;
```

```
4;5;s;6;10;s;
```

```
5;5;mJ/cm2;5;10;mJ/cm2;
```

```
6;5;mJ/cm2;4;5;mJ/cm2;
```

```
7;5;mJ/cm2;3;5;mJ/cm2;
```

```
*****
```

### Settings:

Settings can be password-protected. The PIN is identical to the device PIN on the UV-MAT, see technical data.

Enter the PIN if necessary:

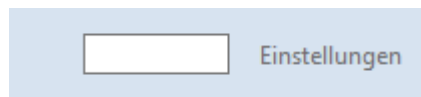

In the settings, it is possible to have a radiation protocol saved automatically and to specify the path for this. In addition, the radiation protocol can be saved as a PDF report in short form and in long form (with data history).

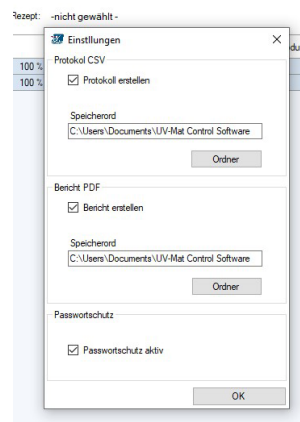

## 15 Technical Data

<b>General data BS-05</b>	
Ambient temperature	+15 to 30 °C
Storage temperature	+ 5 to 60 °C
Humidity	< 80% non-condensing
Cooling	Air cooling
Maximum housing temperature	< 60 °C
Sample temperature	~25-30 °C +/- 5 °C. Add. heating up by UV is about 5 °C
Operating voltage and frequency	110 - 230 VAC, 50/60 Hz
Dimensions, chamber	95 x 82 x 70 cm (L x T x H)
Interior dimensions sample plate	86 x 64 cm
Interior height	28 cm
Weight, chamber	~80 kg
Type	tabletop device
Noise Emission / Noise Declaration for Machines	$L_{pa} < 70$ dB during normal operation according DIN 45635 T. 19 This is to declare that this product is in conformance with the German Regulation on Noise Declaration for Machines
Connection UV-MAT	rear multi-pole connection

<b>General data UV-MAT</b>	
Ambient temperature	0 to 30 °C
Storage temperature	0 to +60 °C
Humidity	< 80% non-condensing
Size (L x W x H)	250 x 185 x 100 mm <sup>3</sup>
Weight	2,6 kg
Maximum housing temperature	< 60 °C
Cooling	Air cooling
Power supply	DC Low voltage, by chamber only
Max input power	~ 12 W
Connection chamber	rear multi-pole connection
Sensor connection	2



<b>General data UV-MAT</b>	
PC interface	USB 2.0
Virtual Serial Port	Baud: 115200 Databits: 8 Parity: None Stop Bits: 1
Display UV-MAT	graphic, 128 x 64 px
Display UV-MAT Touch	Capacitive touch display
Dosisberechnung	for all irradiance measurements > 0.1 mW/cm <sup>2</sup> to avoid offset errors

<b>USB-Connection / Hardware- Software requirements</b>	
PC requirements	min Intel CORE i3, 2 GB Ram, >40 Gb HDD
Operating system	Windows 10 with .NET Framework > 4.0

<b>Installation, minimum clearances</b>	
Installation of the system	horizontal
Minimum clearance, above	4 cm
Minimum clearance, lateral	4 cm

<b>Firmwareversion</b>	
Firmwareversion	1.6.2

<b>PIN</b>	
Code	7243

<b>Inert box*</b>	
Dimensions	404 mm x 313 mm x 111 mm
Irradiation window dimensions	350 mm x 270 mm
Air Inlet & Air outlet connector	Hose connection: diameter 10mm
Evacuatable	No
Max input pressure	0,2 bar, do not close gas outlet

<b>TECHNICAL DATA SENSORS (typical)</b>	
Measuring range	See type, typically 0 - 100 mW/cm <sup>2</sup> to 0 - 10 W/cm <sup>2</sup>
Resolution	0.01 mW/cm <sup>2</sup>
Illuminance measurementsb.	See type, typically 0 - 500,000 lx
Dynamic range	up to 10 <sup>7</sup>
AD conversion	24 bit
Dimensions	Ø 40 mm, h 35 mm
Optical surface	Ø 6 mm
Weight	160 g
Connection cable	2 m
Operating temperature	0 to 40 °C
Storage temperature	-20 to 60 °C
Air humidity	<80%, non-condensing
Cosine correction	yes
Calibration	yes, traceable to PTB / NIST
frequency of checks (Recalibration)	12 months



The technical data for special versions may differ and can be found in the appendices to the special versions.

<b>Spectral ranges of the sensors</b>	
UVC	200 - 280 nm
UVB	280 - 315 nm
UVA	315 - 400 nm
UVA+	330 - 455 nm
UVBB (Broadband)	230 - 400 nm
VISB	400 - 480 nm
VISBG	400 - 570 nm
LUX	380 - 780 nm, V(λ)

UV-lamps / lamps	
Spectral range	type
UVA	F18T8BLB LF (352nm) Sankyo Denki Philips Actinic BL TL-D 18W
UVB	Broadband TL 20W/12 RS Philips TL 20W/01RS UV-B MEDICAL
UVC	TUV F17T8
D-65	Master LT-D 90 Graphica 18W/965
Number of lamps	40

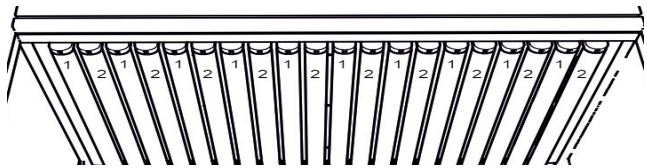
Lamp groups
 <p>Lamp group 1: from left positions 1-3-5-7 (1 marked) Lamp group 2: from left positions 2-4-6-8 (2 marked)</p>

**Typical intensity distribution**

The energy distribution on the drawer sheet metal has the following distribution:

	1	2	3	4	5	6	7	8	9	10	11	12	13
1	74%	76%	78%	79%	80%	80%	80%	80%	81%	80%	79%	77%	76%
2	79%	81%	83%	85%	86%	86%	86%	86%	86%	85%	84%	83%	81%
3	84%	86%	88%	90%	91%	91%	91%	91%	91%	91%	89%	88%	86%
4	87%	90%	92%	94%	95%	95%	95%	95%	95%	94%	93%	91%	90%
5	90%	92%	94%	96%	98%	98%	98%	98%	98%	97%	96%	94%	93%
6	92%	94%	96%	98%	99%	99%	99%	100%	100%	99%	97%	96%	94%
7	92%	94%	96%	98%	99%	99%	99%	100%	100%	99%	97%	96%	94%
8	91%	93%	95%	97%	98%	98%	98%	99%	98%	98%	96%	95%	93%
9	88%	90%	92%	94%	95%	95%	96%	96%	96%	94%	93%	92%	90%
10	85%	87%	88%	90%	91%	91%	92%	91%	92%	90%	89%	88%	86%
11	80%	81%	83%	85%	86%	86%	86%	86%	86%	85%	84%	82%	81%
12	73%	75%	77%	79%	79%	79%	79%	79%	80%	78%	78%	76%	75%
13	66%	68%	69%	71%	72%	72%	72%	72%	72%	70%	70%	69%	67%

The front edge of drawer is at the lower end of the diagram. The brush is at the left side of the diagram and the gap for the grid is 4 cm.

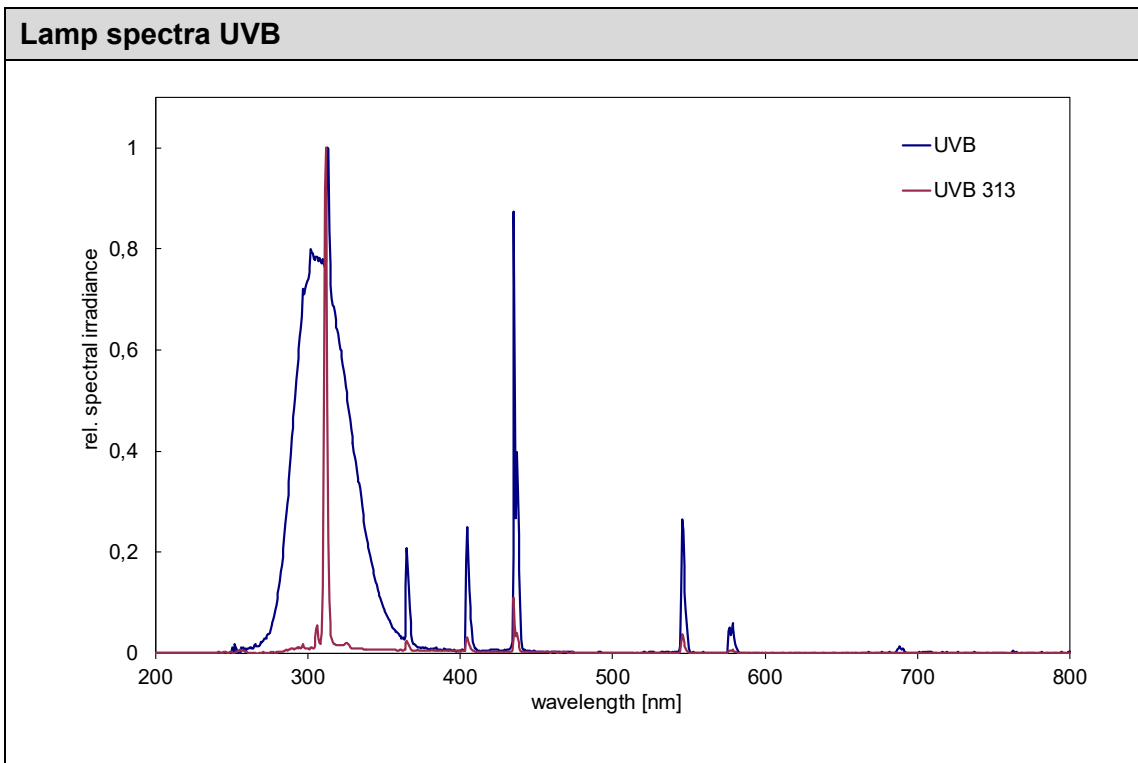
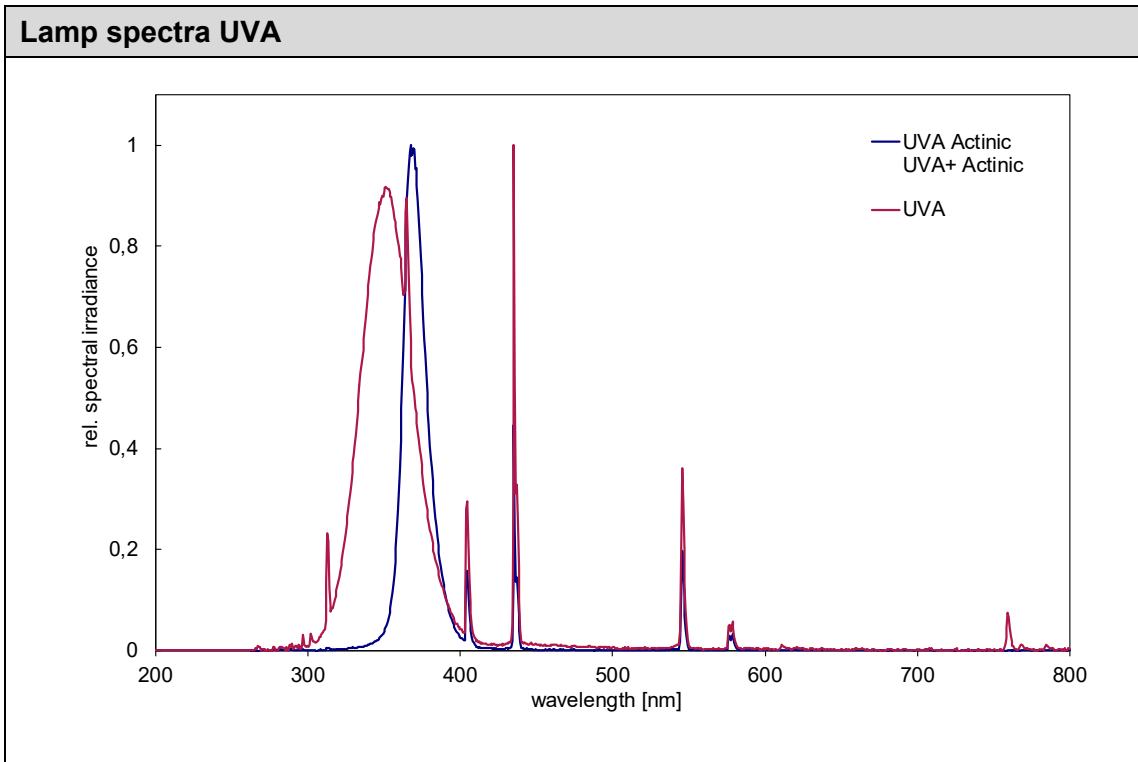

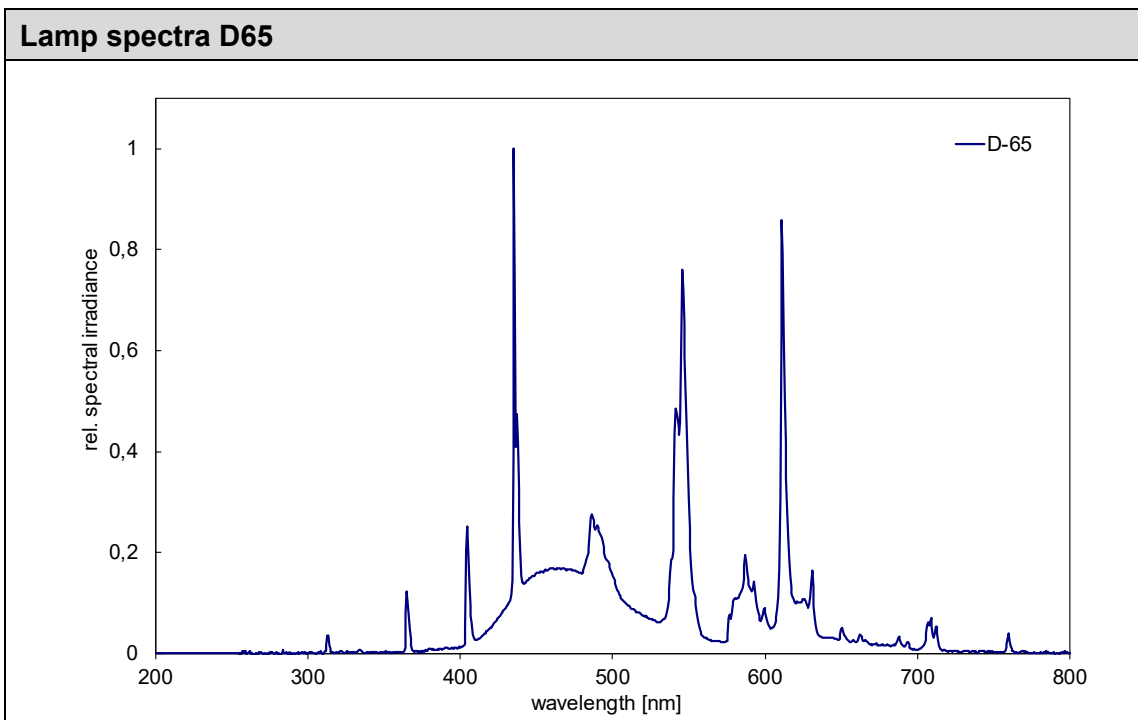
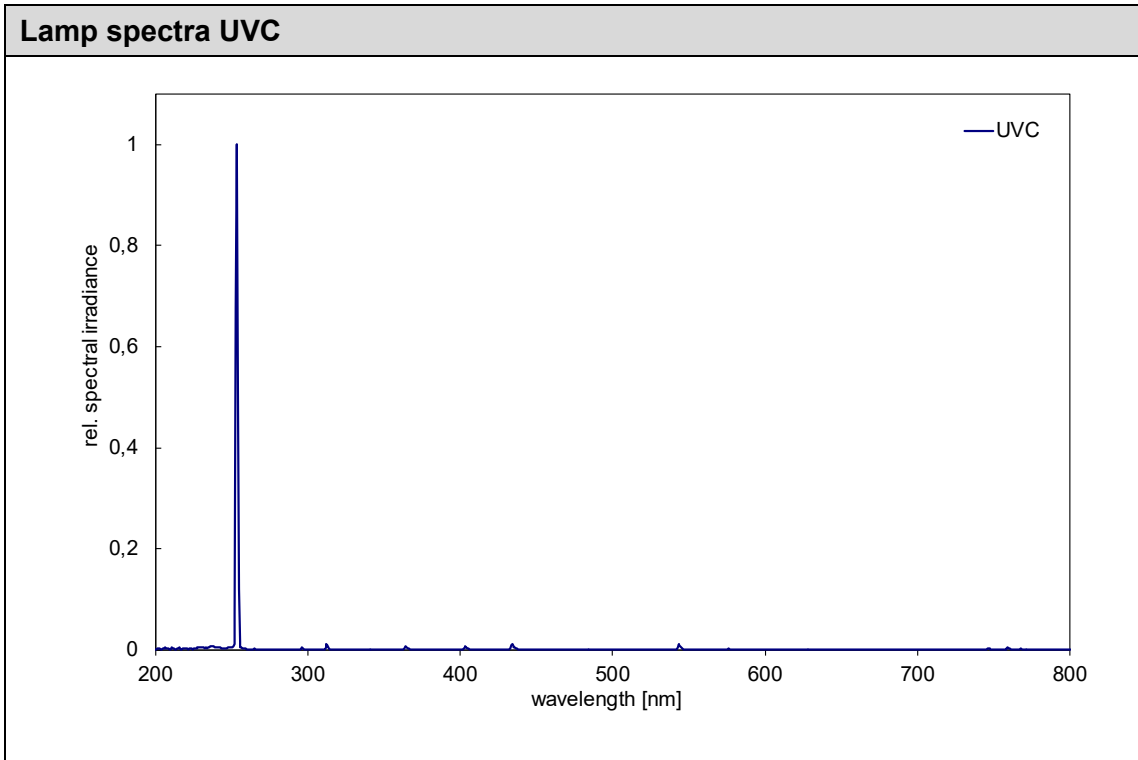

## 16 Maintenance



This chapter is intended for qualified users with maintenance tasks.

The system is largely maintenance-free. Clean the optical components only if necessary.

Turn the irradiation chamber off with the power switch. Disconnect power plug from mains.

The BS-02 is a combined system that needs only cleaning, lamp exchange and recalibration as maintenance.

For cleaning we recommend to make this only on demand and not on a regular base as the side mirrors and sensor surface are sensitive to scratches.

Please use Isopropanol in a UV IR grade to clean sensor/sensors.

The mirrors are cleaned ONLY AS NEEDED with compressed air or isopropanol and a very soft paper towel.

The glass plates are cleaned AS NEEDED with compressed air or isopropanol and a very soft paper towel.

UV lamps are also cleaned with compressed air or isopropanol and a very soft paper towel.

Since this is a combined system, we may need BS-02 and UV-MAT in case of repair. Some spare parts can be modified by the customer. Note, it is not recommended to change parts other than UV lamps themselves. The warranty on spare parts is provided only if the installation and service is done by us.

For recalibration, we only need the sensor.

The following table contains some maintenance steps as a recommendation:

	<b>⚠ WARNING</b>
	<p><b>Risk of injury! Risk of Burns!</b></p> <p>During the irradiation the lamp temperature may rise up to approx. 50° C.</p>

	<b>⚠ CAUTION</b>
	<p><b>Risk of Damage</b></p> <ul style="list-style-type: none"> <li>• Skin fat and dirt are absorbent in the UV and visible spectral range.</li> <li>• Avoid fingerprints on the optically components, sensor surfaces, lamps and reflectors. If necessary, the components must be cleaned carefully with Isopropyl.</li> </ul>

No.	Maintenance Item	Procedure	Recommended frequency
1	Overall checking and cleaning of the machine	Cleaning of bottom side from process chamber. Accumulated dust clean-up, rust check, peeled paint check, leak, broken switch, and damaged covers, otherwise replace it.	Semi-Annual
2	Sensor checking	1. Check sensors, must be free from dirt, otherwise clean / recalibrate it.	Monthly
3	Optical components cleaning	0. Visual inspection of mirrors. Mirrors must be clean. Small dirt can be accepted as the mirrors are sensitive to scratches. Clean only on demand.	Monthly
		1. In case cleaning is needed, use pressurized air or Isopropanol (UV-IR Grade) and a very soft paper towel. Softly clean mirror from left to right, top to bottom. Must be free from cracks and dirt, otherwise replace to new one.	On Demand
4	Door contact checking	Verify and check door contact by its physical appearance. Replace if necessary.	Semi-Annual
5	Intensity checking	Check and get the actual irradiance of the machine using UV sensor (must be calibrated). (Write Value)	Monthly
6	Lamp change	Exchange UV lamps if irradiance is not high enough.	On Demand
7	Calibration	1. Check for calibration by comparison measurement or calibration date.	Annual
		2. Send to manufacturer if recalibration is necessary.	
8	Wiring check	Check all wiring connection for any possible damage or loose connection. Replace if necessary.	Every 6 Weeks
9	Cleaning	Clean the machine body (outside) using wiper to remove dust and dirt	Daily



Only carry out cleaning work on the sensor as required. This gives you the best possible stability. Clean exclusively with isopropanol (UV-IR-GRADE), with oil-free compressed air or with clean, lint-free cloths.

Wear clean, lint-free gloves.

Apply the cleaning agent only to the cloth, only moisten.

The cleaning agent could get inside and cause damage to property.

Wipe with little pressure, in a circular motion over the surfaces.

Then remove all residues of the cleaning agent.

## 16.1 Calibration

We recommend to have the sensors used calibrated every year by the manufacturer to ensure accurate measurement results.

## 16.2 Changing the UV-MAT Touch battery

The measuring instrument is delivered with an internal battery for the real-time clock. Contact the manufacturer to change the battery.



### Note

If the batteries are empty, the real-time clock may deviate.

Without an external supply and without batteries or with empty batteries, the real-time clock is reset. After switching on, the user is prompted to set the real-time clock.

The measurement data is retained.

## 17 Spare Parts



**When ordering spare parts, please contact:**

Opsytec Dr. Gröbel GmbH  
 Am Hardtwald 6-8  
 76275 Ettlingen  
 Germany  
 Phone +49 - 7243 - 94 783 - 50

Visit our website at: [www.opsytec.de](http://www.opsytec.de)

The following spare parts are available for your system:

Designation	Part Number
Air inlet filter set	BS-05-AIF
Air inlet cover set	BS-05-AIC
Left internal side mirror	BS-05-BM
Back internal side mirror	BS-05-RM
Right internal side mirror	BS-05-RM
Air outlet fan	BS-05-AOF
Air outlet filter set	BS-05-AOF
Air outlet cover set	BS-05-AOCS
Connector end caps for cables	BS-05-EC
Bottom plate	BS-05-BP
Front door with internal mirror	BS-05 BS-05-Door
Door contact	860801L-DC
UV-MAT	specify serial number
Sensor	See sensor type
Sensor recalibration	710001
Sensor recalibration, DAKKS	17055
Other Parts	On request

## 18 Declaration of Conformity



Manufacturer :	Company name: Opsytec Dr. Gröbel GmbH Street: Am Hardtwald 6-8 City: 76275 Ettlingen Country: Deutschland
Person authorized to compile the technical documentation	Company name: Opsytec Dr. Gröbel GmbH Street: Am Hardtwald 6-8 City: 76275 Ettlingen Country: Deutschland
Product:	Irradiation chamber with UV lamps, UV dose controller UV-MAT and sensor(s)
Type designation:	BS-05
Type number:	860 905 XXXX, 860 901 860 920 XXXX, 860 930 XXXX 814 4XX XXXX, 8608XX, 87000X

The manufacturer hereby declares that we have developed, designed and manufactured the above product(s) under our sole responsibility and that the product complies with the following standard(s) or directive(s) in this declaration:

2006/42/EG

"Directive of the European Parliament and of the Council on machinery and amending Directive 95/16/EG (Machinery Directive)".

2014/30/EU

Directive of the European Parliament and of the Council relating to electromagnetic compatibility (EMC Directive, recast)".

Ettlingen, 26.08.2020

gez. Dr. Mark Paravia

This document was created electronically and is valid without signature.

