

Irradiation chamber BSL-04

Instruction

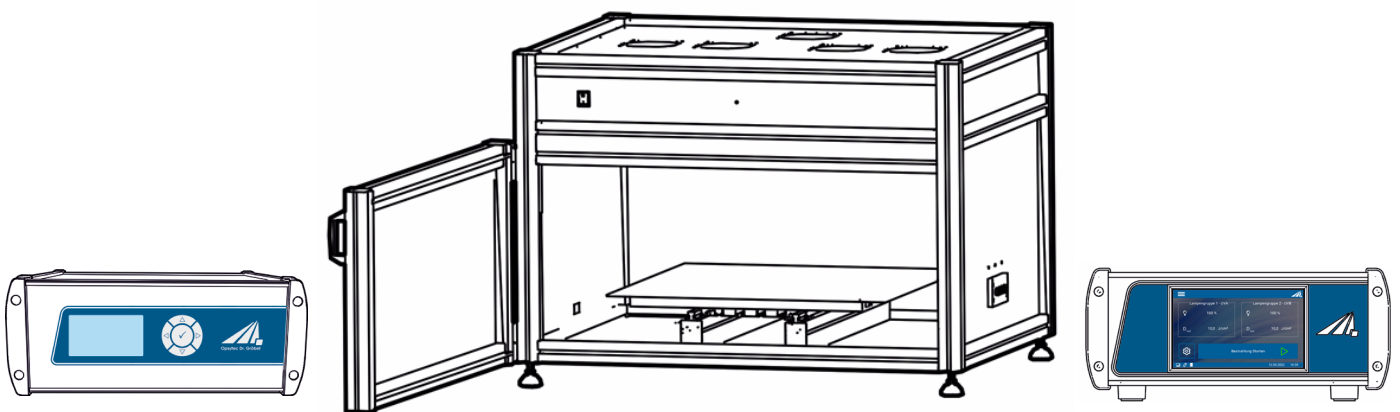

Version: 1.3.2E

Opsytec Dr. Gröbel GmbH
Am Hardtwald 6-8
D-76275 Ettlingen

Phone: +49(0)7243 / 9 47 83-50
www.opsytec.de
info@opsytec.de

1 Table of contents

1	Table of contents	2
2	Foreword.....	5
3	Quick start guide.....	6
4	Guidelines and standards	8
5	Important information.....	9
5.1	Manufacturer.....	9
5.2	Change history.....	9
5.3	Copyright	9
5.4	Identification of the Device.....	9
5.5	Intended use	10
5.6	Foreseeable misuse	11
5.7	Legal information	11
5.7.1	Limitation of liability	11
5.7.2	Declaration of Conformity.....	11
5.7.3	Warranty conditions.....	11
6	General.....	12
6.1	Information about this manual	12
6.2	Information about the symbols	13
6.2.1	Safety instructions	13
6.2.2	Prohibition Signs	13
6.2.3	Warning Signs	14
6.2.4	Attention	14
6.2.5	Fire Protection Sign.....	15
6.2.6	Rescue Sign	15
6.2.7	Optional functions.....	15
6.3	Owner/operator information.....	16
6.4	Personnel requirements.....	17
6.4.1	Qualifications.....	17
6.4.2	Electrically skilled person	17
6.4.3	Qualified person	17
6.4.4	Operators	18
6.4.5	Training and Qualification of Personnel	18
6.5	Personal Protective Equipment	19
6.5.1	Protective Gloves	19
6.5.2	Protective Goggles	19
6.5.3	Safety Boots	19
7	Safety Information and Residual Risk	20
7.1	General	20
7.2	Safety instructions relating to normal operation	21
7.3	Radiation safety	23

7.4	Safety instructions relating to service and repair work	24
8	Description of the system and function overview	26
9	Commissioning	30
9.1	Commissioning and Use of inter box*	32
10	Technical data	33
11	Operation	36
11.1.1	Switch on and off	37
11.1.2	Led On / Off	38
11.1.3	Start / Stop	38
11.1.4	Performance change	39
11.1.5	Operating mode	40
11.1.6	Irradiation time	40
11.1.7	Setting the dose	41
11.1.8	Start / stop irradiation	43
11.2	Settings and setup	44
11.2.1	Sensor factor	44
11.2.2	Units	45
11.2.3	Settings, menu language setting	46
11.2.4	Setting the menu language	46
11.2.5	Status	46
11.2.6	Sensor information	46
11.2.7	USB settings	47
11.2.8	Decimal separating oaks	47
11.2.9	Settings, fan*	48
11.2.10	Settings, version	48
11.3	Setup - Other settings	48
11.3.1	Safety time*	49
11.3.2	Upper and lower limit / Calibration each spectral range*	49
11.3.3	Sensor error	50
12	Operation with a UV-Mat Touch	51
12.1	Switch on / Switch off	51
12.2	Introduction to the user interface	52
12.3	Setting the setpoints	53
12.3.1	Dimming	53
12.3.2	Operating mode	55
12.4	During irradiation	56
12.4.1	Display irradiation	57
12.4.2	Dimming display	58
12.4.3	Scope display	58
12.5	After irradiation	59
12.6	Data recording	59
12.7	User settings	60
12.7.1	Sensors and chamber factors	60

12.7.2	Language	61
12.7.3	Time.....	62
12.7.4	Menu/Display.....	62
12.7.5	Record	63
12.7.6	Fan	64
12.7.7	Operating hours.....	64
12.7.8	Reset	64
12.7.9	Firmware update	65
12.8	Information.....	65
12.9	Error messages	67
13	USB logging* and REMOTE operation*	69
13.1	Software installation.....	70
13.2	Establish connection with the PC	70
14	Software - UV-MAT Control for UV-MAT Touch*.....	71
14.1	Working with the software.....	73
15	Maintenance	75
15.1	Insert sensor and sensor exchange	77
15.2	Calibration.....	78
15.3	LED insertion and LED replacement	78
15.4	Error / malfunction	78
16	Spare parts	79
17	Declaration of Conformity.....	80
18	NOTES.....	81

2 Foreword

Dear Customer!

Thank you for choosing a product manufactured by us!

Please take your time to read this manual carefully. Please pay special attention to the safety instructions.

This is the condition for safe handling and safe operation of the system and its components.

If you have any questions that you do not find answered in this manual, please call us and we will be pleased to assist you. In addition, we always welcome any suggestions or proposals for improvement.

Our products undergo constant advanced development; therefore, there may be minor differences between your system and the illustrations given in this Operating Manual.



Please note that the manufacturer of this device accepts no liability for the quality of the irradiation result of the irradiated material, as this depends on many factors. Always check the irradiation result after irradiation and adjust the irradiation if necessary.

**THIS MANUAL CONTAINS IMPORTANT SAFETY INSTRUCTIONS.
KEEP THESE INSTRUCTIONS.**

This is a translation of the original operating manual.

© 2023

Opsytec Dr. Gröbel GmbH

Am Hardtwald 6-8

D - 76275 Ettlingen

All rights reserved. Reprinting, including excerpts, is only permitted with the written consent of Opsytec Dr. Gröbel GmbH.

3 Quick start guide

The quick guide should demonstrate the installation and some of the system functions to trained personnel. You will find the detailed instructions on in this manual. Please pay special attention to the safety instructions given in the complete manual.



As an alternative to the UV-MAT Touch, we offer the UV-MAT. You will find the operation in separate chapters and refer to only one type.

Commissioning:

- Unpack all components and remove the packing materials.
- The BSL-04 is supplied with UV LEDs mounted. You do not need to install them.
- Make sure that the air inlets and outlets are not covered.
- Connect the UV-MAT to the irradiation chamber using the cable supplied.

When a sensor has been ordered:

- Mount the sensor in the holder below the irradiation chamber.
 - Therefore, remove the base plate and the sensor holder.
 - Now insert the sensor.
 - Replace the sensor holder and screw it tight again.
 - Feed the sensor cable through the cable gland on the back of the irradiation chamber.
 - Connect the sensor to the UV-MAT.
- Connect the irradiation chamber to the mains voltage.
- Switch on the system using the switch on the front of the irradiation chamber.

Operation:

- Open the front door of the irradiation chamber and place the objects to be irradiated in the irradiation chamber.
- Make sure that the built-in sensor is not covered during dose-guided radiation.
- Close the front door of the irradiation chamber, otherwise the UV LEDs will not light up.
- Select the operating mode: Timer or Dose*.
- If necessary, check the irradiation intensity and use ∇ and \triangle keys to adjust the radiation intensity and check the sensor factor (see chapter 10.5).
- Start the irradiation with the UV-MAT. At the end of the exposure, open the front door of the irradiation chamber and carefully remove the irradiated objects. Do not forget to switch off the UV-MAT.



Information on safety instructions can be found from page 20.

Information on commissioning and operation can be found from page 30.

4 Guidelines and standards



The system is machinery under Annex II A of the Machinery Directive and is therefore delivered with a declaration of conformity and with a CE mark (in accordance with the Machinery Directive).

Directives	
EC Directives	06/42/EC (Machinery) (partially observed) 2014/30/EC (EMC) 2014/35/EC (Low voltage)
Harmonized standards	
EN ISO 12100:2010	Safety of Machinery – General Principles for Design Risk Assessment and Risk Reduction
EN 61000-6-2:2005	Electromagnetic compatibility (EMC) - Part 6-2: Generic standards - Immunity for industrial environments
EN 61000-6-4:2007+A1:2011	Electromagnetic compatibility (EMC) - Part 6-4: Generic standards - Emission requirements for industrial environments

5 Important information

5.1 Manufacturer

Opsytec Dr. Gröbel GmbH
 Am Hardtwald 6-8
 D - 76275 Ettlingen
 Tel.: +49(0)7243 / 9 47 83-50
 info@opsytec.de
 www.opsytec.com

5.2 Change history



We reserve the right to make changes to the content. Opsytec Dr. Gröbel GmbH is not liable for any errors in this documentation. No liability is accepted for indirect damage arising from the supply or use of this documentation, to the extent permitted by law.

Version	Processor	Date	Change
1.2.1E	Paravia	20.07.2017	Editorial changes
1.2.4E	Paravia	11.12.2017	Adjustment operation
1.3.0E	Paravia	20.7.2021	Settings fan
1.3.1E	Paravia	17.02.2022	Customization for BSL-04
1.3.2	Paravia	03.04.2023	UV-MAT Touch added

5.3 Copyright



Opsytec Dr. Gröbel GmbH shall retain the copyright for these operating manual. The operating manual is intended for the owner/operator and his personnel.

Copyright in accordance with DIN ISO 16016:

Reproduction and copying of this document, use and disclosure of its contents are prohibited unless expressly authorized.

Non-compliance may result in a claim for damages. All rights reserved in case of registration of patent, utility patent, or design patent.

Contraventions may be subject to prosecution.

5.4 Identification of the Device

For internal use at customer site:

Description of machinery:	Irradiation chamber BSL-04
Year of construction:
Machine No.
Project no.

5.5 Intended use

The BSL-04 irradiation chamber is an curing chamber for various UV applications such as.

- Curing of adhesives and polymers for small parts
- Irradiation of printed circuit boards and wafers
- Accelerated aging of plastics and similar materials with UV radiation

The system is intended for industrial use only. It is prohibited to use the equipment in explosive environments or for general lighting. Installation, commissioning, operation, maintenance and service works must solely be performed by trained and educated, qualified personnel, which observes all safety regulations and standards.

- Responsibility: Damages resulting from unintentional or unauthorized interventions terminate every right, to raise warranty or liability claims against the manufacturer.
- Guarantee exclusion: The use of any non-original parts voids the guarantee.
- Environmental protection: Defect parts, which may contain environmentally harmful substances, must be disposed of accordingly.
- During the operation a high-energy UV and/or visible radiation is generated.
- Operation is only permitted in a dry environment. The installation is horizontal.
- Only suitable for the operation in closed rooms.
- This device is not intended to be used in residential areas and cannot ensure adequate protection of a radio reception in such environments. Class A devices according to EN 55011 are intended for use in the "industrial electromagnetic environment". When operating in other electromagnetic environments, their electromagnetic compatibility may be affected.
- Prior to opening, the system must be disconnected from the voltage and it must be checked that there is no voltage present.
- Wear gloves for maintenance, cleaning and exchanging the leds and optical components.
- The system must not be cleaned when in operation.
- The door must not be opened during irradiation. The front door is monitored. Should it be opened during the irradiation, the UV LEDs will automatically switch off. Since this is done with a slight delay, the user will possibly be briefly exposed to UV radiation.
- Any other use than the above mentioned, results in damages to the product.
- Furthermore, it is associated with risks such as short circuits, fire and electric shocks. The entire device must not be changed and/or modified! The safety notes must be observed at all times.

	⚠ CAUTION
	<p>The system may fall down! Damage to the device and personal injury are possible</p> <ul style="list-style-type: none">• Always carry the irradiation chamber with two people.

5.6 Foreseeable misuse

The following is considered foreseeable misuse:

- Operation of the device without safety devices and equipment.
- Activities of uninstructed personnel on the device.
- Non-compliance with the operating instructions of the owner/operator.
- Ignoring of the operating manual.
- Any other use outside the intended specified use.

5.7 Legal information

5.7.1 Limitation of liability

All the information in this manual was compiled with consideration of the currently valid standards and regulations, of the technical standard and our long-standing knowledge and experience.

The manufacturer shall not be liable for damage in the event that:

- This manual is ignored,
- The device is improperly used,
- Untrained personnel is deployed,
- Untrained personnel operates the machine incorrectly,
- Unauthorized modifications are made,
- Technical changes are made,
- Non-approved spare parts are used.

We shall not be liable for common faults of the device caused by power outage or failure of the control system.

The actual scope of delivery may be different than the explanations and pictures in this manual in case of special versions, when additional options are ordered or due to the latest technical changes.

The obligations agreed in the delivery contract, as well as the legal requirements valid at the time the contract was concluded shall apply.

5.7.2 Declaration of Conformity

The declaration of conformity is in the annex or can be requested from the manufacturer.

5.7.3 Warranty conditions

The warranty terms and guarantee conditions are governed by the German Civil Code (BGB). The warranty period is one year unless otherwise agreed in the purchase documents.

6 General

6.1 Information about this manual

This manual intends to make handling of this system and its components safe and efficient. The manual is part of the system and must be kept in its immediate vicinity where it is accessible for the personnel at any time.

This documentation contains the necessary information for the intended use of the described system. It is intended for technically qualified personnel who have been especially trained for operation, laboratory use, quality assurance, service and repair.

The personnel must have read this manual carefully and understood its content before commencing any work. The basic condition for safe working is observation of all stated safety information and operating instructions in this manual.

Knowledge and technically faultless implementation of the instructions, safety requirements, safety information and warnings are a condition for safety in operation, service and repair. Only qualified personnel has the required professional knowledge to apply the safety requirements, safety information and warnings stated in this operating manual in a general way correctly in a concrete situation.

In addition, the local accident prevention regulations and general safety regulations apply for the area of application of the system.

Illustrations in this manual serve the purpose of general understanding; they may differ from the actual version.

Apart from this manual the instructions for the installed components included in the appendix apply.

This operating manual cannot take any possible case of maintenance into account. If you need further information or if special problems occur that are not treated extensively enough in this manual please request the required information from the manufacturer.



For a simple description, the above mentioned components are collectively referred to as system.

6.2 Information about the symbols

6.2.1 Safety instructions

In this manual, safety information is indicated by means of symbols. Safety information is preceded by signal words that indicate the scope of risk.

To avoid accidents and damage to persons or property, always follow the information and act prudently.

Throughout the text, you will find the following pictograms with the following meanings:

	⚠ DANGER
	<p>Imminent danger Possible consequences: death or most serious injuries.</p> <ul style="list-style-type: none"> • Prevention

	⚠ WARNING
	<p>Dangerous Situation Possible consequences: death or most serious injuries.</p> <ul style="list-style-type: none"> • Prevention

	⚠ CAUTION
	<p>Possible Situation Possible consequences: slight or minor injuries. Sometimes also used for warning of material damage.</p> <ul style="list-style-type: none"> • Prevention



Note

Information for use or useful important information

6.2.2 Prohibition Signs



General "Prohibited-sign"

6.2.3 Warning Signs



Warning of optical radiation
(such as UV, IR, or visible radiation)



Warning of hot surface!



Warning of electricity!

6.2.4 Attention



Wear eye protection!



Opaque eye protection must be worn!



Disconnect mains plug from electrical outlet!



Disconnect before carrying out maintenance or repair!



Use hand protection!



Wear foot protection!



Refer to instruction manual/booklet

6.2.5 Fire Protection Sign



Extinguishing hose



Fire extinguisher

6.2.6 Rescue Sign



Emergency exit: marking of all emergency exits with this symbol

6.2.7 Optional functions

- * Optional functions, not available for every system

6.3 Owner/operator information

The System is used in the commercial sector. The owner/operator of the system is therefore subject to the legal obligations concerning work safety.

In addition to the safety information in this manual, the generally applicable regulations valid for the application area of the system concerning safety, prevention of accidents and for protection of the environment must be noted and complied with.

The following applies in particular:

The owner/operator must acquire information about the valid occupational health and safety information and in a risk assessment determine additional hazards incurred due to the special operating conditions at the location of use of the system. He must implement these in the form of operating instructions for operation of the system and specifically for the individual work stations.

The owner/operator is obliged to check during the entire lifetime of the system whether the operating instructions that he generated comply with the current status of the regulations and update them if necessary.

The owner/operator must assign and define the responsibilities for installation, operation, rectification of faults, service and cleaning unambiguously.

The owner/operator must ensure that all personnel dealing with the system have read and understood this manual. Furthermore, he is obliged to provide personnel training in regular intervals and provide information about risks.



The owner/operator must provide the required personal protective equipment for his personnel. Furthermore, the owner/operator is responsible that the system is always in faultless technical condition. To ensure this, the service intervals specified in this manual and in the technical documents for the individual systems must be observed and all safety installations must be checked regularly for function and completeness.



The owner/operator must have all safety devices checked regularly for function and completeness.

The owner/operator must ensure that the operating personnel have knowledge about first aid measures and local rescue installations.

6.4 Personnel requirements

6.4.1 Qualifications

	 WARNING
	<p>Risk of injury when personnel are insufficiently qualified!</p> <p>If unqualified personnel carries out work on the system or stays in the danger area of the system risks arise that may cause severe injuries and serious material damage.</p> <ul style="list-style-type: none"> • Have all activities carried out only by personnel qualified for the activity. • Keep unqualified personnel away from the danger area.

	 WARNING
	<p>Risk of injury when touching live parts or hot surfaces</p> <p>Generally, low voltage devices like this system can have dangerous live parts and hot surfaces. All works for transportation, installation, commissioning, start-up and maintenance must be performed by respectively trained and responsible, qualified personnel (in accordance with EN 50110-1 (VDE 0105-100); IEC 60364). Inappropriate behavior can lead to serious injuries or damages.</p> <p>During the irradiation the LED temperature may rise up to approx. 60° C. Caution - risk of burns.</p>

Below, this manual lists the qualifications of the personnel for the various areas of activity:

6.4.2 Electrically skilled person

Due to their professional training, knowledge and experience and knowledge of the relevant standards and regulations, electrically skilled persons are able to carry out work on electrical systems and to recognize and avoid risks independently.

Electrically skilled persons are specially trained for the work environment where they are working and they know the relevant standards and regulations. Electrically skilled persons must fulfil the requirements of the valid legal regulations for accident prevention.

6.4.3 Qualified person

Qualified persons are trained or can be trained by Opsytec Dr. Gröbel GmbH in extended operation and parameterization of the system as well as in execution of preventive service work.

In addition, due to their technical training, knowledge and experience and knowledge of the relevant standards and regulations, they are able to carry out work they have been assigned and to recognize and avoid possible risks independently.

6.4.4 Operators

Operators use and operate the system in the scope of the intended use. They are trained by the owner/operator in the work assigned to them and informed about possible risks.

6.4.5 Training and Qualification of Personnel

In regular instructions and training, operating personnel must be informed about the special risks when working with and handling the system.

The instruction and training should have the following content:

- Hazards when working with the system in normal operation.

- Hazards in connection with service, repair and cleaning activities.

- Conduct to minimize consequences of accidents.

- Conduct in case of accidents.

- Rescue of injured persons.

- Working without personal protective equipment may cause health damage. The company supervisor is instructed to pay attention that personnel are wearing personal protective equipment.

- Particular hazards when working on the electrical system.

Instruction and training must be carried out in regular intervals by the owner/operator. For better tracking, execution of instruction and training should be recorded.

6.5 Personal Protective Equipment

The purpose of personal protective equipment is to protect the personnel from risks that might affect his safety or health when working.

When executing various activities on and with the system, the personnel must wear personal protective equipment. This will be pointed out again in the individual chapters of this manual. Below, personal protective equipment is explained:

6.5.1 Protective Gloves

Protective gloves are used to protect hands from visible and invisible radiation, friction, abrasion, stabs and deep injuries.

6.5.2 Protective Goggles

Protective goggles are used to protect eyes from intense visible and invisible radiation.

Protective eyewear and storage boxes can be ordered from Opsytec Dr. Gröbel GmbH, Am Hardtwald 6-8, 76275 Ettlingen or UVEX AREITSSSCHUTZ GMBH, Würzburger Str. 181 - 189, 90766 Fürth, Germany:

Protective eyewear part number: 9169065

Storage box part number: 9957502

	⚠ CAUTION
	Use eye protection when working with the light source in the hazardous area.

	⚠ CAUTION
	Keep the safety goggles protected at the application site when not in use.

6.5.3 Safety Boots



Safety boots are used as protection from heavy parts falling down and slipping on slippery surfaces.



7 Safety Information and Residual Risk

7.1 General





The system is state-of-the-art and has been built in compliance with recognized safety regulations. Nonetheless, its use may constitute risks for life and limb of the operating and repair personnel (service personnel) or third parties or impairments to the machine. Operate the system only when its safety devices are in faultless condition. Disruptions that impair its safety must be rectified at once.



The following safety information must be strictly observed to prevent damage to the machine and personal injury!

 WARNING	
	<p>Risk of injury when personnel do not read the operation manual!</p> <p>Prior to commissioning and operation, read the operation manual completely. Read all safety information and instructions. Negligence concerning safety information and instructions may cause electric shock and/or severe injuries.</p>

 CAUTION	
	<p>The system may fall down! Damage to the device and personal injury are possible</p> <ul style="list-style-type: none">• Always carry the system with two people.

7.2 Safety instructions relating to normal operation

	<p style="text-align: center;">⚠ DANGER</p> <p>Danger to life Danger to life occurs when the system is operated with defective or absent safety devices.</p> <ul style="list-style-type: none"> The system should be operated only when all protective devices and safety-related installations are present and in working condition. The operator of the machine is obliged to check the safety devices for proper function regularly before production is started.
	<p style="text-align: center;">⚠ WARNING</p> <p>Risk of Fire! An extremely high irradiance, which can ignite combustible materials in cases of permanent radiation, is reached inside at the top of the irradiation chamber. Do not place any combustible material direct under the LEDs and observe the irradiation time and the material temperature.</p>
	<p style="text-align: center;">⚠ WARNING</p> <p>Risk of injury when touching hot surfaces During the irradiation the LED temperature may rise up to approx. 60° C. Caution - risk of burns.</p>
	<p style="text-align: center;">⚠ CAUTION</p> <p>Risk of Damage</p> <ul style="list-style-type: none"> Skin fat and dirt are absorbent in the UV and visible spectral range. Avoid fingerprints on the optically active sensor surface. If necessary, the components must be cleaned carefully with Isopropyl. Use safety goggles and gloves when working inside sample room of the BSL-01 irradiation chamber.

 CAUTION	
	<p>Risk of Damage</p> <p>The system warms up during operation.</p> <ul style="list-style-type: none">• Make sure that there is an adequate air circulation at the installation site.• Air vents in the device housing and the LED modules must not be covered.

For activities in normal operation a brightness of at least 300 Lux must be provided.

Access to the machine is only permitted for operating personnel and instructed personnel.

Operation the machine is only permitted for instructed operating personnel.



Removing or disabling protective devices is not allowed during operation of the system.



If any protective devices or equipment fail or have become faulty, this must be reported to the operations supervisor immediately. He will decide about further procedure.



Please note that the manufacturer of this device accepts no liability for the quality of the irradiation result of the irradiated material, as this depends on many factors. Always check the irradiation result after irradiation and adjust the irradiation if necessary.

7.3 Radiation safety

	 WARNING
	<p>Risk of eye injury UV-radiation is harmful! Always wear suitable safety glasses. Avoid direct exposition.</p> <p>This product is equipped with UV and visible high intensity LEDs. There is a risk of photo-chemical or thermal damage of the eye, retinal damage of the eye and erythema. The operating staff is to be trained appropriately.</p> <p>For protection of the operating staff, do not look into the UV light and do not expose the skin continuously to UV radiation.</p> <p>Note: In case of a malfunction, the UV light can be switched on, even though the status LEDs or the trigger output does not signalize this. Before working with the device, please check that the LEDs are switched off.</p>

	 WARNING
	<p>Risk of eye injury</p> <p>This product is equipped with UV and visible high power LEDs. There is a risk of photochemical or thermal damage to the eye, damage to the retina of the eye and erythema. The operating personnel must be trained accordingly.</p> <p>Do not look into the LED and do not expose skin to radiation!</p> <p>Avoid reflections of the radiation into the eye!</p> <p>The built-in LEDs were classified in risk group 3 according to DIN EN 62471:2009-03 "Photobiological safety of lamps and lamp systems".</p> <div style="display: flex; justify-content: space-around; margin-top: 10px;"> <div style="border: 2px solid black; background-color: yellow; padding: 5px; text-align: center;"> <p>DIN EN 62471:2009-03 Risk group 3 Luminaires pose a hazard even for transient or brief irradiation. Use in general lighting is not permitted.</p> </div> <div style="border: 2px solid black; background-color: yellow; padding: 5px; text-align: center;"> <p>Caution dangerous ultraviolet & visible radiation</p> </div> </div>

7.4 Safety instructions relating to service and repair work



	⚠ WARNING
	<p>Risk of injury! High Weight! Always carry the system with two persons.</p>

	⚠ WARNING
	<p>Risk of injury when touching live parts Before opening the system, disconnect all components from the supply voltage and check that no voltage is present.</p>

	⚠ WARNING
	<p>Risk of injury! The maximum led temperature can reach > 60 °C. There is a risk of skin burns on contact. Allow the system to cool down (> 30 min) before dismounting.</p>

	⚠ CAUTION
	<p>Risk of Damage</p> <ul style="list-style-type: none"> • Switch off the control unit prior to connecting / disconnecting accessories. Due to the operating voltage of the unit, the accessories can get damaged. • Unplugging & plugging of signal cables during the operation is strictly forbidden!

	⚠ CAUTION
	<p>Risk of Damage</p> <ul style="list-style-type: none"> • Skin fat and dirt are absorbent in the UV and visible spectral range. • Avoid fingerprints on the optically components, sensor surfaces, LEDs and reflectors. If necessary, the components must be cleaned carefully with Isopropyl.

 CAUTION	
	<p>Risk of Damage</p> <p>The system warms up during operation.</p> <ul style="list-style-type: none">• Make sure that there is an adequate air circulation at the installation site.• Air vents in the device housing must not be covered.

Service, repair and cleaning work must only be carried out by authorized and specifically trained professionals. The system must be power-free and secured before major work is carried out (including cleaning).

Carry out the prescribed setting, service and inspection work according to schedule. If you need further information or if special problems occur that are not treated extensively enough in this manual please request the required information from the manufacturer.

Only specialized electricians may perform work on electrical equipment.

Safety devices may only be removed during service and repairs, if the system was previously switched off and brought into a safe condition.

For service and maintenance work, important safety installations may not be functional. Work of this kind therefore requires special caution.

8 Description of the system and function overview

The UV LED chamber BSL-04 is the largest irradiation chamber in the BSL series. The high irradiance combined with the exact dose control offers a unique reproducibility for perfect results!

The wavelengths 365 nm, 385 nm, 395 nm, 405 nm and 450 nm are available for your application. Due to the irradiance of up to 110 mW/cm² and the high homogeneity, even very large parts or batches can be irradiated.

For high irradiances, the UV LED chamber can be ordered completely with one LED wavelength. A particularly flexible application is possible when two separately controllable LED wavelengths are ordered.

Compared with our irradiation chambers of the BS series, the BSL-04 offers an irradiance that is 14 times as high. The high irradiance allows for extremely short exposure times. With the high homogeneity of the irradiation, the samples can also be positioned as needed.

Due to the typical characteristics for UV LEDs, such as "immediate start", the dimmability and the high durability, the BSL-04 is ideally suited for medium-sized laboratory tests and curing of large components.

The integrated timer already controls the irradiation in an exact way. For even better results, we recommend one of our calibrated sensors. The dose control is already integrated in the UV-MAT Touch and UV-MAT control units in the BSL-04 UV LED chamber. By means of an optional sensor, the UV-MAT measures the irradiance continuously, and stops the irradiance at the set target dose.

Due to the little heat input of the UV LEDs and a sample room temperature of ca. 40 °C, thermal damage is minimized.

The sample room has a floor space of 86 x 64 cm and a height of 28 cm. Parts that must be bonded or cured can be positioned easily on the movable sample carrier.

The operating personnel is fully protected from UV radiation in the completely closed and monitored irradiation chamber.

The components at a glance:

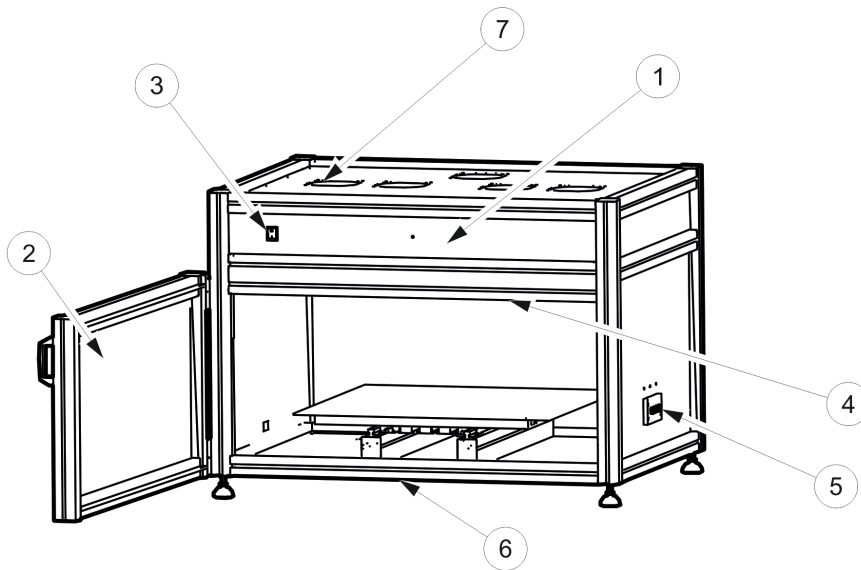

Pos.	Designation	Pos.	Designation
1	Irradiation chamber	2	Front door
3	Main switsch	4	LED lamps
5	Front door	6	Air-inlet
7	Air-outlet		

Rear side and ventilation concept:

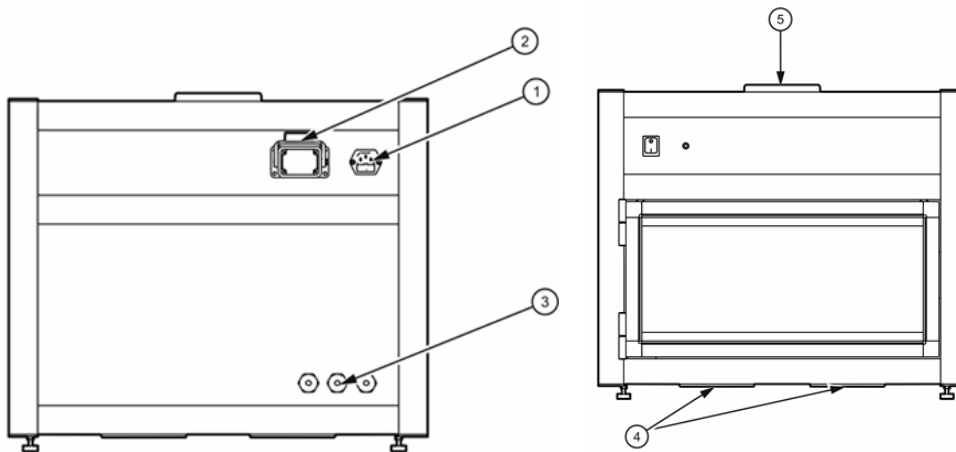

Pos.	Designation	Pos.	Designation
1	Mains supply line	2	Connection to UV-MAT
3	cable feed-through	4	Air inlet
5	Air outlet		



(1)



(2)

Pos.	Designation	Pos.	Designation
1	UV-Mat Touch	2	UV-Mat

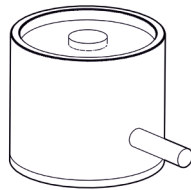

(1)

Pos.	Designation	Pos.	Designation
1	Sensor		

The following components are supplied:

- Irradiation chamber
- UV-MAT or UV-MAT Touch
- Mains cable
- this documentation
- Optional:
 - Sensor
 - Inert Box



For ease of description, the above components are collectively referred to as the system.

The following components are required by the customer:

- None
- Optional nitrogen box

9 Commissioning

- Unpack all components and remove the packing materials.

	⚠ WARNING
	Risk of injury! High weight! Always carry the irradiation chamber with two people.

- The BSL-04 is supplied with UV LEDs mounted. You do not need to install them.
- Make sure that the air inlets and outlets are not covered.
- Connect the UV-MAT to the irradiation chamber using the cable supplied.

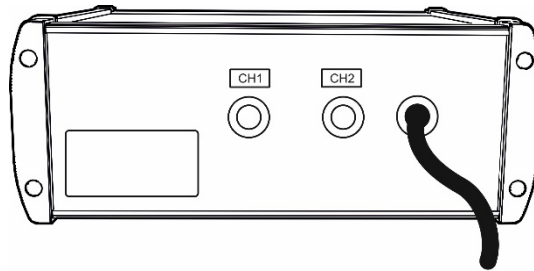



(Image similar)

When a sensor has been ordered:

- Mount the sensor in the sensor holder below the irradiation chamber.
 - Remove the base plate and the sensor holder.
 - Now remove the sensor or reinsert the sensor.
 - Replace the sensor holder and screw it tight again.
 - Feed the sensor cable through the cable gland on the back of the irradiation chamber.
 - Connect the sensor to the UV-MAT.
-
- Connect the irradiation chamber to the mains voltage.
 - Switch on the UV-MAT using the switch on the front of the chamber.
 - The irradiation is controlled on the UV-MAT.

Operation:

- Open the front door of the irradiation chamber and place the objects to be irradiated in the irradiation chamber.
- Make sure that the built-in sensor is not covered during dose-guided radiation.
- Close the front door of the irradiation chamber, otherwise the UV LEDs will not light up.
- Select the operating mode: Timer or Dose*.
- If necessary, check the irradiance and use the and keys to adjust the irradiance and check the sensor factor (see chapter 10.5).
- Start the irradiation with the UV-MAT. At the end of the exposure, open the front door of the irradiation chamber and carefully remove the irradiated objects. Do not forget to switch off the UV-MAT.

 WARNING	
	<p>Risk of damage</p> <p>To prevent thermal overheating, sufficient ventilation must be ensured at all times.</p> <p>Take special care that the ventilation openings are not covered during operation and that sufficient cooling is ensured.</p>

9.1 Commissioning and Use of inter box*

If your chamber is equipped with an inert box:

Unpack inert box and clean front window with ISOPROPANOL alcohol.

Air-inlet and air-outlet can be changed depending on customer needs.

Pull the connecting hoses for the N2 input and N2 output through the rear openings of the irradiation chamber.

Attach the connecting hoses to the inert box.

Open the inert box with the four screws on the top and place the parts to be irradiated in the inert box.

Place the inert box in the irradiation chamber. Flush inert box until output gas oxygen concentration is below required limit. As an alternative: Flush inert box for several minutes.

Irradiate!

After irradiation, proceed in reverse order.

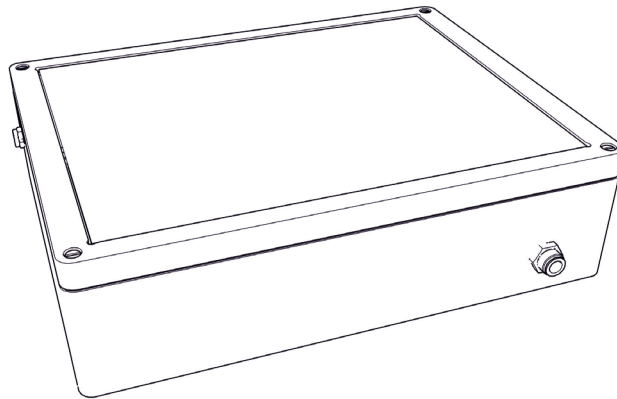

(Image similar)

	⚠ WARNING
	Risk of injury! Do not evacuate the inter box. Inert box is not made for evacuation.

10 Technical data

General data	
Ambient temperature	+15 to 40 °C
Storage temperature	+ 10to +60 °C
Sample temperature	~40 °C +/- °C5. additionally due to UV irradiance
Design, control electronics	Desktop device
UV LEDs	365nm, 385nm, 395nm, 405nm or 450nm
Dimensions irradiation chamber	95 x 82x 70 cm (W x D x H)
Dimensions UV-MAT	~ 18,5 cm x 25 cm x 10 cm
Maximum housing temperature	< 60 °C (BSL-04)
Weight	~ 70 kg
Interior chamber	86 x 64 cm
Sliding sample carrier	64 x 49 cm
Interior height	28 cm
Cooling	Forced air cooling
Noise emission	Lpa < 70 dB at the workplace in normal operation according to DIN 45635 T. 19
Emission class	A, according to DIN EN 55011:2022-05

Mounting position, minimum distances	
Body position	horizontal
Minimum distances, top	4 cm
Minimum distances, lateral	4 cm

Power supply and connections	
Operating voltage and frequency	see type plate on chamber
Maximum input power	see type plate on chamber
Fuse	see type plate on chamber
Connection UV-MAT	rear multi-pole connection

General data UV-MAT	
Ambient temperature	0 to 30 °C
Storage temperature, approx.	0 to +60 °C
Humidity	0% to 80% rel. humidity, non-condensing
Dimensions, approx.	250 x 185 x 100 mm ³ (L x W x H)
Weight	approx. 2,6 kg
Maximum housing temperature	< 60 °C
Operating voltage and frequency	DC 24V (via irradiation chamber)
Maximum input power	approx. 12 W
Connection irradiation chamber	rear multi-pole connection
Sensor input	1 Piece
PC connection	USB 2.0
Virtual Serial Port	Baud: 115200 Databits: 8 Parity: None Stop Bits: 1
Display	graphic, 128 x 64 px
Dose calculation	for all irradiance readings > 0.1 mW/cm ² to avoid offset errors

USB / Hardware Software Requirements	
PC requirements	min Intel CORE i3, 2 GB Ram, >40 Gb HDD
Operating system	Windows 10

Mounting position, minimum distances, UV-MAT	
Body position	Desktop, horizontal
Minimum distances, top	2 cm
Minimum distances, lateral	2 cm

Firmware version	
Firmware version	1.6.2

TECHNICAL DATA SENSORS (TYPICAL)	
Measuring range	0 - 10 W/cm ²
Resolution	0.001 mW/cm ²
Dose measuring range	0 - 100 MJ/cm ²
Dynamic range	up to 10 ⁷
AD conversion	24 bit
Temperature sensor	integrated
Dimensions	Ø 40 mm, h 35 mm
Optical surface	Ø 6 mm
Weight	160 g
Connection cable	2 m
Operating temperature	0 to 40 °C
Storage temperature	-20 to 60 °C
Humidity	<80%, non-condensing
Preferences	
Factor channel 1	See attached documentation



The factors are used to calculate the irradiance at a different position (than at the sensor position). They are independent of the sensor calibration.



For the recalibration we only need the sensor(s).

PIN	
PIN	7243



The pin secures important settings from unauthorized change. It is required in the Setup menu.

11 Operation



As an alternative to the UV-MAT, we offer the UV-MAT Touch.
This chapter only refers to the operation on the UV-MAT.

After starting the device, the logo first appears on the display. Then the device is in standby and the main menu is displayed. The menu items in the main menu depend on the settings. For example, the menu items "Power0.. 100%" and "Irradiation time" are only displayed if the corresponding mode has been selected.

The BSL-04 is operated via five keys on the UV-MAT control unit. These are located on the front panel to the right of the display. The keys and the function assignment are shown below:

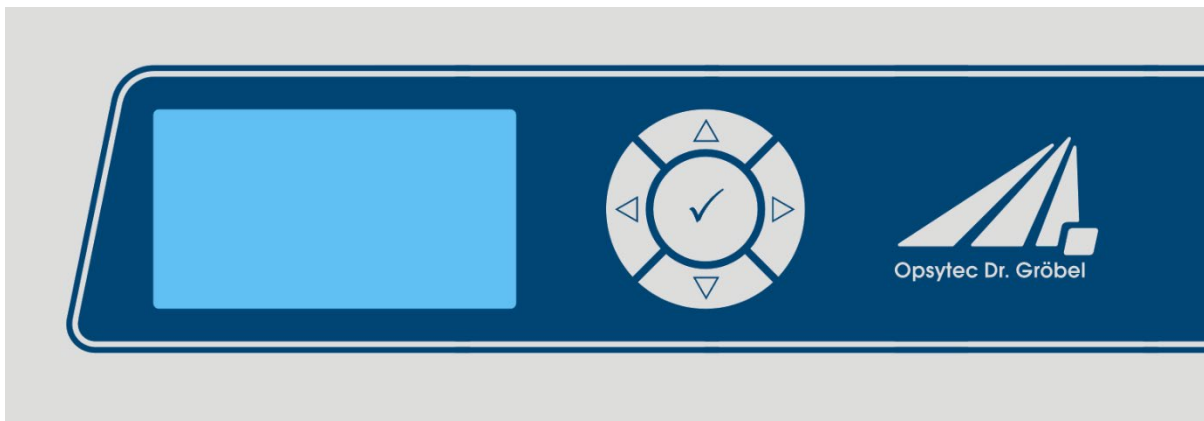

Key	Function
▽	Down
△	Up
◀	Left
▶	Right
✓	Confirm / OK

In the main menu and all other menus, select the active menu item via the keys ▽ and △. By clicking ✓ you confirm the selected menu item. With ◀ you return to the previous menu without adopting the changes.

The selected menu item is highlighted in black and displayed inverted.

The UV-MAT has two operating modes:

- Timer mode
- Dose operation

MAT offers two modes of operation:

- Equipment operation on the UV-MAT

- Remote (via programming interface, USB)

The menu items depend on the settings. For example, the "Irradiation time" menu item is only displayed if the corresponding timer mode has been selected.

11.1.1 Switch on and off

Switch on the UV-MAT at the switch on the back.

After switching on, the start logo appears for approx. 2 seconds:



The irradiation chamber is then automatically checked. After a successful check, the main menu appears:

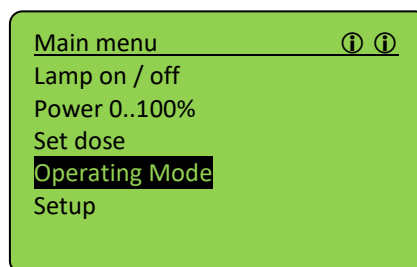

The menu items in the main menu depend upon the settings, i.e. the menu items "Performance 0..100%" and "Irradiation time" are only displayed, when the respective mode has been selected.

In the main menu and all other menus, select the active menu item via the keys ∇ and \triangle . By clicking \checkmark you confirm the selected menu item. With \triangleleft you return to the previous menu without adopting the changes.

The selected menu item is displayed on a black background and inverted.

The status is displayed in the upper right corner (\textcircled{i} \textcircled{i}). The symbols below have the following meaning:

- \textcircled{L} LED on
- \textcircled{O} LED off
- \textcircled{T} Timer mode
- D Dose mode

11.1.2 Led On / Off

When the LED / lamp is on, the display will show the status screen. Example:

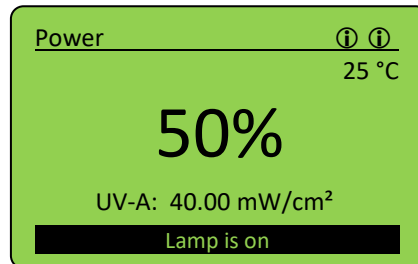

With the keys ∇ and \triangle the power can be modified during the operation.

The status screen displays the current power, internal or external control, and error messages. If your UV-MAT is designed for multiple LED modules, the outputs of the individual modules are displayed in the status screen.

From the status screen, press to return to \triangleleft the main menu.



Note

The LED is switched off by pressing the key (\checkmark).

The and keys can now be used to change the power during operation.

11.1.3 Start / Stop

In timer mode, the LED lamp is started for the preset exposure time and then switches off again automatically. The exposure can be canceled by pressing the (\checkmark) key.

The and keys can now be used to change the power during the exposure (continuous on).



Pressing the (\checkmark) key cancels the irradiation.

11.1.4 Performance change

Select the "Power0.. 100%" menu item in the main menu.

In the main menu select the menu item "Power 0..100%". In the submenu you can select the decimal with the keys ◀ or ▶ and set the power with the keys ▲ or ▼ to the desired value. Confirm with OK (✓) to return to the main menu.

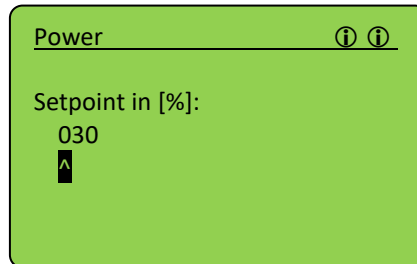

Settings below 2% and above 100% are reset to the limit values.



Power settings can be changed during irradiation with keys ▲ or ▼.

If your UV-MAT is designed for several LED wavelengths, select "all channels" or "single channel" in the submenu:

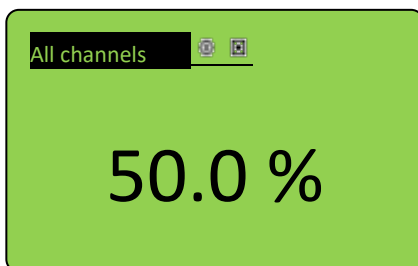

All channels

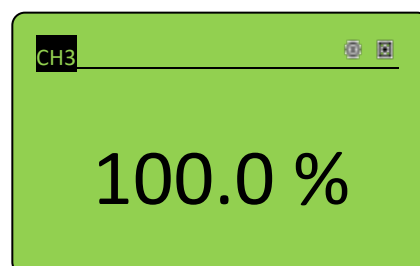

single channel

Note: The dose control does not fall back on the dim setting, but ends the irradiation at the dose reached.



The irradiance can also be adjusted during irradiation using the and keys if the dimming option is available.

11.1.5 Operating mode

In the Operating mode menu, you can switch between continuous operation, timer mode and dose operation.

In dose-controlled mode, irradiation is automatically stopped when the target dose is reached.

In time-controlled operation (timer), the irradiation time is controlled. Only the irradiation time is shown on the display. No sensor is required for time-controlled irradiation, so that the irradiation chamber can continue to be used, e.g., during recalibration of the sensor.

Select dose-controlled or time-controlled irradiation in the Operating mode submenu.

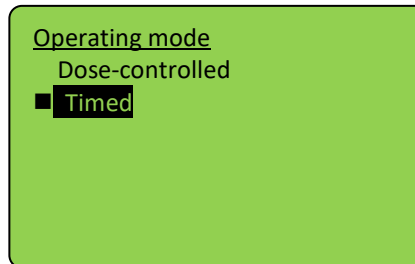

Confirm with the OK key (✓). Press the key to cancel the entry and return to the previous menu.



In dose-controlled mode, irradiation is controlled automatically and stops when the desired dose is reached. Note that a sensor must be connected.



In timed mode, the irradiation time is controlled only by a timer. A sensor is not required.
The irradiation time can be selected individually for both channels.

11.1.6 Irradiation time

In the menu “Irradiation Time” you can set the irradiation time for the timer. Therefore select menu item “Set time”. If “Set time” is not displayed, please choose “Timer” in menu “Operation Mode” first.

Now you can select the decimal with the keys ◀ or ▶ and with the keys ▲ or ▼ you can set the time to the desired value. Confirm with OK (✓) to return to the main menu.

In timer mode you can set the duration of irradiation:

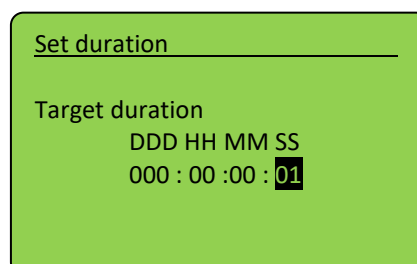



The maximum duration is 999 days, 23 hours, 59 minutes and 59 seconds.

The irradiation time can be set differently for both channels.

In timer mode, the LED is started for the pre-set exposure time and it switches off automatically afterwards. By clicking (✓), you can abort the exposure. Start irradiation with “Start/Stop”

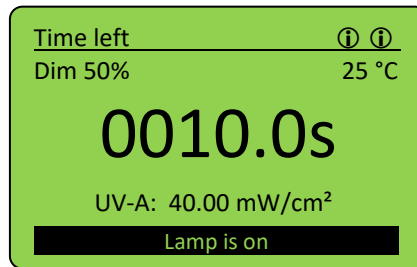

By clicking (✓) the LED is switched off.

With the keys ▾ and ▴ the power can be modified during the exposure.



By clicking (✓) the exposure is aborted.
The maximum duration is 9999 s.

In time controlled mode the irradiation time controlled by a timer only. On the display the irradiation time and, if sensor is connected the irradiance, are displayed. A sensor is not necessary for timer mode.

11.1.7 Setting the dose

Select operation mode dose.

Confirm by with ✓ or ▷. With ◁ you can cancel your input and go back to main menu.



In dose controlled mode the irradiation time is automatically controlled and stops if the desired dose is reached. Note a sensor must be connected therefore.

Set the target dose for an irradiation:

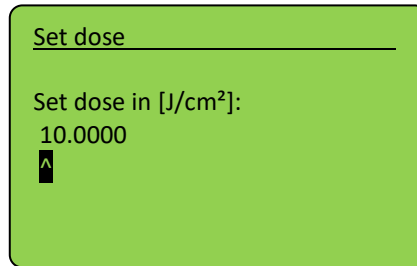

Use the ◀ key to add a digit.

Use △ and ▽ keys to change value and confirm with ✓.

Return to main menu and start an irradiation by selecting “Start Radiation”.

In dose controlled operation mode the current irradiance in mW/cm², the actual irradiation time, the current dose (Is:) and the target dose (Set:) are displayed:

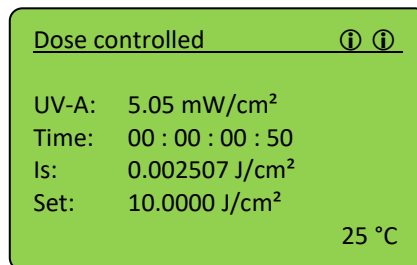

mW/cm² and J/cm² are automatically calculated.

In dose-controlled operating mode, the current irradiance in mW/cm², the current irradiation time, the current dose (Actual:) and the target dose (Target:) are displayed:

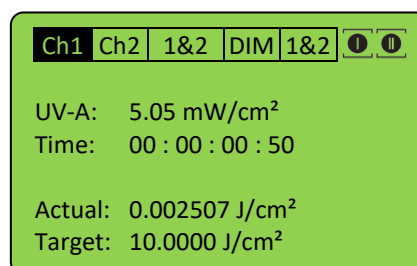

mW/cm² and J/cm² are calculated automatically.

Stop an irradiation by pressing ✓ for at least 2 seconds.

11.1.8 Start / stop irradiation

Start the irradiation by confirming the menu item "Start irradiation" in the main menu with OK (✓).

In the timed operating mode, the current irradiation time and the end times are displayed in the format DD: HH: MM: SS.

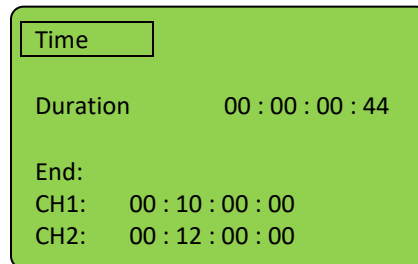

In the dose-controlled operating mode, the irradiance in mW/cm^2 , the irradiation time, the current dose (actual) and the target dose (target) are displayed:

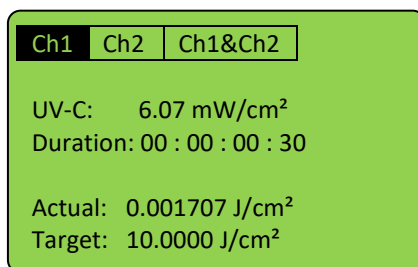

Use the and keys to change the display.
The units mW/cm^2 and J/cm^2 are calculated automatically.

You can cancel the irradiation via the key. To do this, hold the key ✓ pressed for at least 2 seconds.

11.2 Settings and setup

In this menu you can make the system settings.

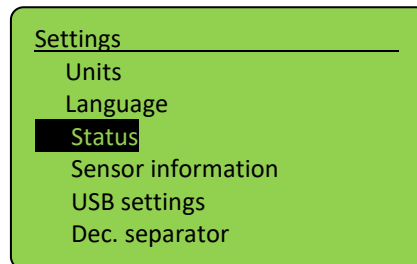
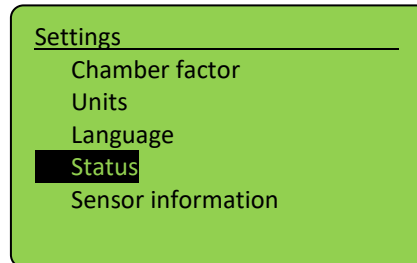

The system settings can be changed in the "Setup" submenu. For this purpose, the PIN, see *Technical data*, must be entered.

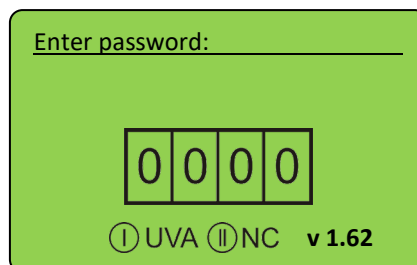

After entering the PIN and confirming with OK (✓), the setup menu is displayed:

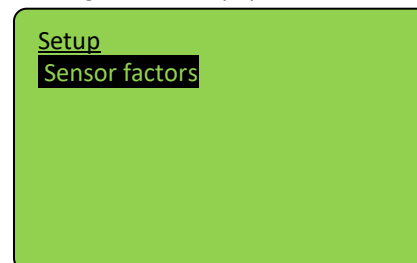

It is possible to set a sensor factor.

11.2.1 Sensor factor

The sensor factor is used to calculate and output the irradiance at a different position (than at the sensor position). Thus, the displayed irradiance is the same even if measured at the lateral sensor position.

The sensor factor has already been determined and preset by the manufacturer. See the technical documentation in the appendix.



This setting should be tested for different specimen sizes / specimen heights. The initial setting was made centrally, approx. 35 mm above the specimen level (chamber bottom).

Example:

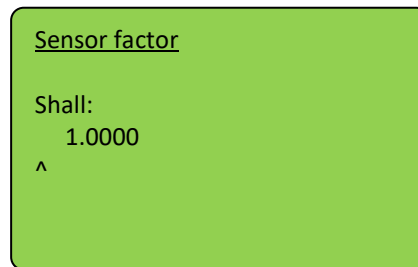

If you want to use the irradiance at any position, proceed as follows:

- Set as sensor factor: 1.0000
- Measure the irradiance at (any) position 1.
- Measure the irradiance at the sensor position.
- Divide the irradiance at position 1 by the irradiance at the sensor position. The result is the sensor factor.
- Set the sensor factor.



Use the key to add a digit.

Navigate with \triangleleft , \triangleright and set value with \triangle , ∇ . Confirm with \checkmark to go back to setup menu.

11.2.2 Units

The units are adjustable and are automatically converted internally. The setting specifies the unit in which the measured values of the sensors are displayed. This is a setting for the sensor that applies to the measured channel (including dose).

Possible units are:

- $\text{mW/cm}^2 \Rightarrow \text{mJ/cm}^2$
- $\text{W/m}^2 \Rightarrow \text{J/m}^2$
- $\mu\text{W/cm}^2 \Rightarrow \mu\text{J/cm}^2$

11.2.3 Settings, menu language setting

The menu languages German and English are available. The setting is made in the "Setting" menu, then "Language".

11.2.4 Setting the menu language

The menu languages German and English are available. You make the setting in the "Settings" menu, then click "Language".

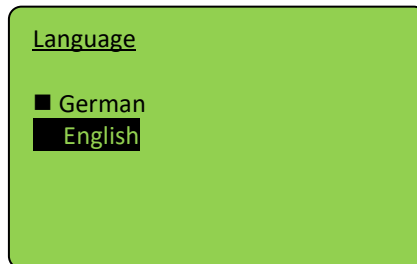

Select the desired language with the keys ∇ and \triangle and confirm with \checkmark .

11.2.5 Status

Status information is given here:

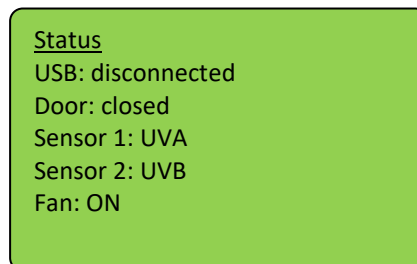

Back with \checkmark .

11.2.6 Sensor information

Sensor-specific information can be called up under the menu item. Only connected sensors appear in the Info menu.

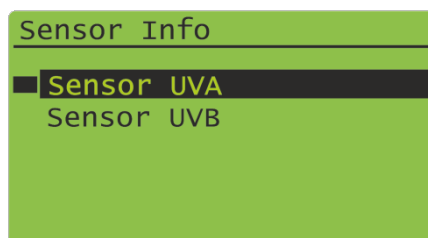

Select the sensor. Information about the sensor is displayed. If no sensor is connected, this menu item is not displayed.

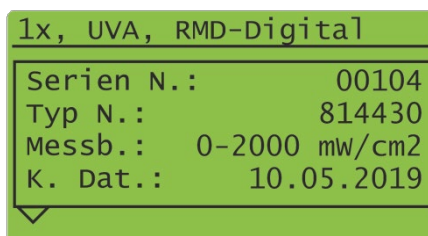

11.2.7 USB settings

This queue item enables or disables USB output and control:

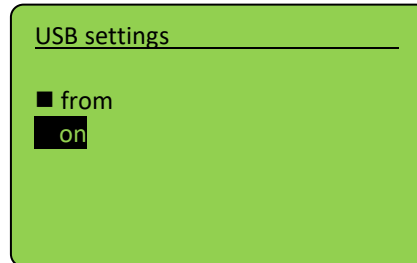

Back with ✓ .

Subsequently, the cyclic transmission time is set. This is the time interval between automatic status information of the chamber.

11.2.8 Decimal separating oaks

Here the decimal separator for the USB output is selected:

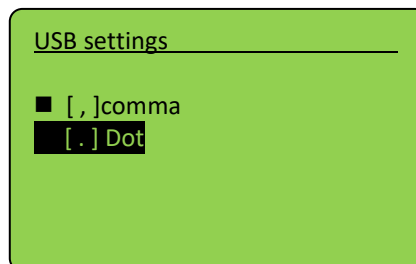

11.2.9 Settings, fan*

For lower power requirements, the fan speed and thus both the cooling capacity and the noise emission can be reduced.

Two ventilation levels are included here:

- Exposure
- Basic

The fan speed can be set separately in both ventilation stages.

In addition, the overrun time can be set in minutes and seconds. The overrun time uses the "Exposure" ventilation stage for additional cooling after the exposure is completed.



If necessary, your system can be equipped with a parameterization lock so that no fan speeds that are too low are selected.



The temperature monitoring is independent of the fan speed and can, if a critical temperature is exceeded, temporarily deactivate the ventilation stage and increase the fan speed to protect the system.

11.2.10 Settings, version

Shows the installed firmware version:

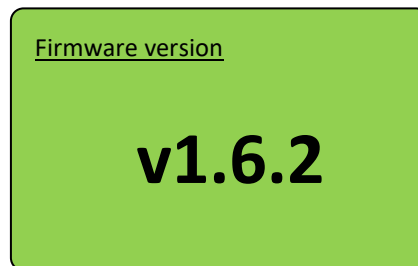

11.3 Setup - Other settings

In this menu you can make the system settings. For this purpose, the PIN code, *see chapter Technical data*, must be entered.

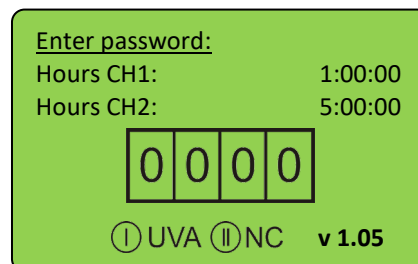

Even without PIN, the operating hours, the connected sensors and the firmware version are displayed. After entering the PIN and confirming with OK, you can change the system settings:

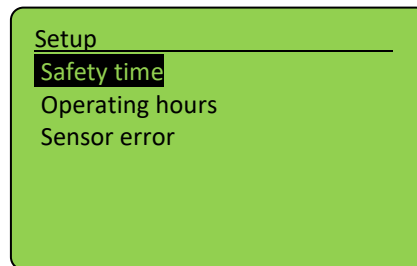

These are stored in this submenu for each spectral range. For this purpose, the spectral range is selected first and then the setting is made.

11.3.1 Safety time*

The time values can be set in the "Safety time" menu. See delay time, max. time and waiting time.

Delay time*

The delay time is the time, which the UV-Mat waits until it starts to monitor the sensor signal. It should be as long as the leds need to get on a constant irradiancy delivery.

Max. time*

Max. time is a safety function. After reaching this time the irradiation is stopped.

Waiting time*

The waiting time is the time after the irradiation which must be waited to start a new irradiation. This time should be so long, that double irradiation is to be excluded. It should be set at least to **3 seconds** to prevent immediate user restart.

11.3.2 Upper and lower limit / Calibration each spectral range*

The upper and lower limits have the function of monitoring the sensors. For example:

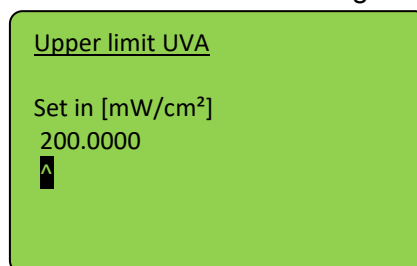

For the determination of the limit values you have to set the upper limit on e.g. 300 mW/cm² and the lower limit on 0 mW/cm². No error can occur with this setup (if the calibration factor is set to 1.0). After an adequate warm up time you have to read the values and can now adjust the upper and lower limit e.g. ±25% of the sensor value. Strong fluctuations during the warming up should be faded out with the delay time.

11.3.3 Sensor error

Setting to select whether sensor errors cancel irradiation or not.

Sensor error

activate

disable

12 Operation with a UV-Mat Touch

The UV-Mat Touch is characterized by its capacitive touch display and the extended functions compared to the UV-MAT. In addition, remote control via USB is possible.



As an alternative to the UV-MAT Touch, we offer the UV-MAT. This chapter only refers to the operation on the UV-MAT Touch.

The display can be operated with a finger. The display is not suitable for other objects, such as ballpoint pens.

The UV-MAT has two operating modes:

- Dose-controlled
- Time controlled (no sensor is needed)

The menu items in the main menu depend on the settings, i.e. the menu items "Dimming" and "Irradiation time" are only displayed if the respective mode has been selected.

12.1 Switch on / Switch off

After starting the device via the switch of the irradiation chamber, the logo and some information about the system first appear in the display.



After approx. 3 s, the main screen appears. This contains information about the settings of the individual lamp groups. Irradiation is started from here.

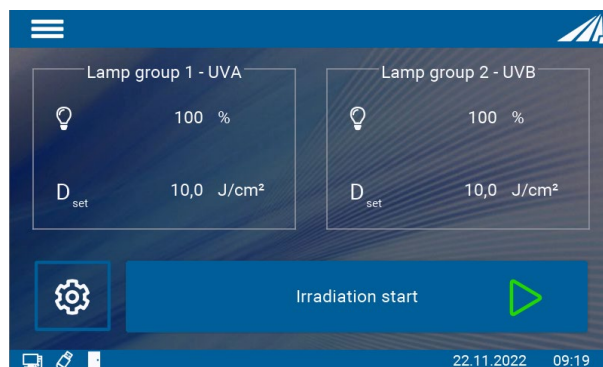



When the device is switched on for the first time, the date and time should be checked and set if necessary.

Turn off the system at the switch on the front panel.



The operating mode and the set power are saved permanently.
After a restart, the last operating mode is selected (exception: settings).

12.2 Introduction to the user interface

The UV-MAT Touch has an intuitive user interface. All values relevant for the measurement are displayed in the center of the screen. The various menus Measurement screens are explained in the following chapter.

After switching on, the main screen appears. This contains information about the settings of the individual lamp groups. Irradiation is started from here.



The main screen contains information about the settings of the individual lamp groups. Irradiation is started from here.

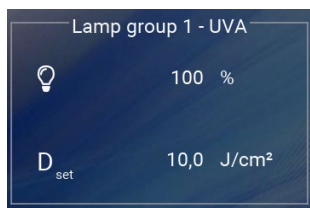

This area displays the current settings of the individual lamp groups.



















Here in the example, both channels are independently dose controlled and the lamp intensity is 100% for both.

It is possible to enter the settings menu of the respective lamp group by pressing the box with a finger.

Clicking on the menu symbol at the upper left edge opens the **main menu**. The menu closes either by clicking the [x] symbol, by clicking outside the menu or automatically after 5 s.



The different menus Measurement screens are explained in the following chapter. Here the symbols mean:

Symbol	Function
	Menu
	Settings menu
	Start irradiation
	USB connection to a PC
	USB stick plugged
	Sensor temperature
	Sensor designation
	Sensor channel
	Sensor error
	Irradiation chamber door is closed
	Irradiation chamber door is open
	Display date & time
	Opens a numeric input window
	The lock icon appears when the GUI is locked to the condition.
	Measured value recording running / stopped
	The battery symbol indicates that the real-time battery of the device is exhausted.
	Cancel and return to the main menu
	Saves a screenshot

12.3 Setting the setpoints

Both groups of lamps can be adjusted independently of each other. There are essentially two setting options:

1. Dimming: 2-100%
2. Operating mode: time or dose controlled

12.3.1 Dimming

The dimming of the individual lamp groups can be adjusted by pressing a button on the respective lamp group box in the main screen.

This keystroke takes you directly to the settings menu. Both lamp groups can be found under the menu item "Dimming". It is possible to set each lamp group separately or both to the same value. This can be done by pressing the button "Lamp group 1+2".

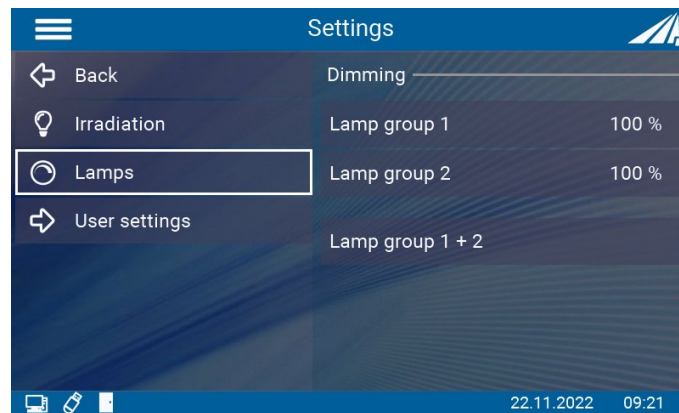

Clicking on one of the three fields opens a numeric block that can be used to set the power.

Minimum 2%: Lamp lights dimly

Maximum 100%: Lamp lights at full power

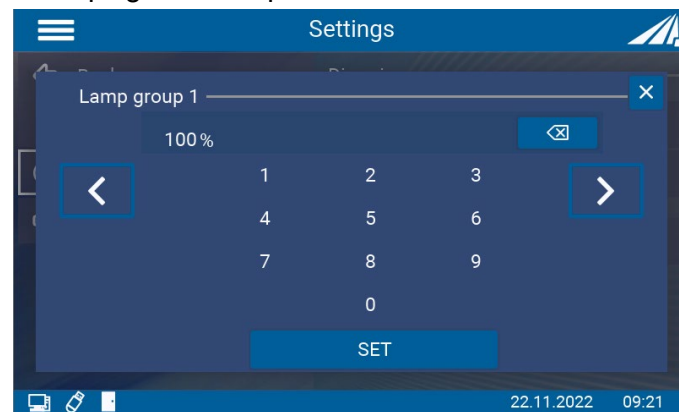

Current input

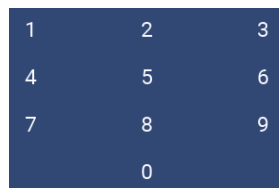

Numeric keypad via which the desired value is entered



Deletes the current input



The cursor can be moved left and right with the arrow keys. Alternatively, the desired cursor position can be selected by clicking in the input field



With OK the input is confirmed and saved



Closes the field without saving

12.3.2 Operating mode

There are two operating modes to control the lamp duty cycle. One is via the time and the other is via the dose. In dose-controlled mode, the irradiation is automatically stopped when the target dose is reached.

In time-controlled operation (timer), the irradiation time is controlled. Only the irradiation time is shown on the display. No sensor is required for time-controlled irradiation, so that the irradiation chamber can continue to be used, for example, during recalibration of the sensor.



In dose-controlled mode, irradiation is controlled automatically and stops when the desired dose is reached. Note that a sensor must be connected.



In timed mode, the irradiation time is controlled only by a timer. A sensor is not required.

The irradiation time can be selected individually for both channels.

This setting can be accessed by pressing the respective lamp group box in the main screen. Both operating modes can be found in the Irradiation menu item. The desired operating mode can be selected here by pressing a key.

12.3.2.1 Dose operating mode

In dose-controlled mode, irradiation is automatically stopped when the target dose is reached.

In the Dose mode, a desired value can be set for each group, at which the lamp is to be switched off when reached.

It is also possible to select a value for both lamp groups together.

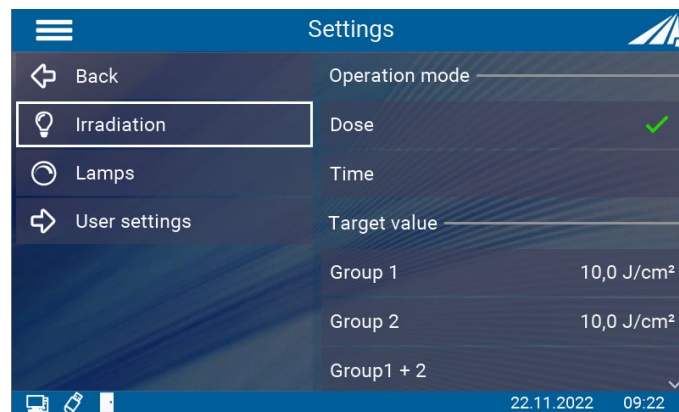

If you scroll down, you will find another setting option.

The channel control can be used to set which sensor should be active for which lamp group. It is also possible to activate one sensor for both lamp groups.

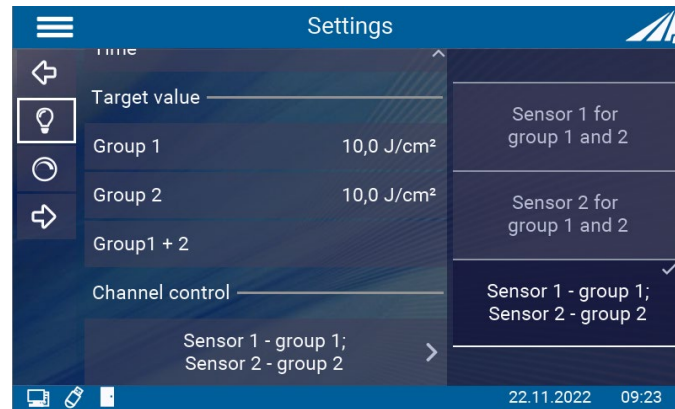

12.3.2.2 Time operating mode

In time-controlled mode, you can set the duration of irradiation for each channel:

To do this, select the "Time setting" menu item. If "Time setting" is not displayed, please first select "Time controlled" in the " Operating mode" menu.

In the time-controlled mode, the irradiation time is controlled only by a timer. The display shows the irradiation time and, if a sensor is connected, the irradiation intensity. A sensor is not required for the timer mode.

In the Time operating mode, an individual time can be set for each channel, after which the lamps are switched off.

It is also possible to select a value for both lamp groups together.

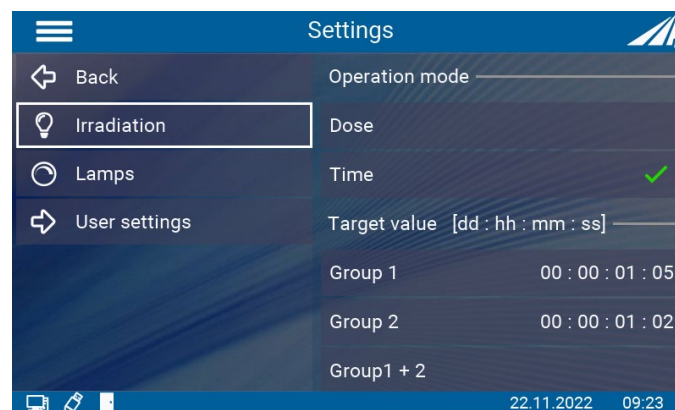

12.4 During irradiation

The UV-MAT Touch includes different measurement screens to cover the various measurement requirements. During irradiation, three different views can be selected. These are: Irradiation, Dimming and Scope. These are selectable via the tabs. Alternatively, the display can be changed by swiping to the right and left.

Here the symbols mean:

 100 %	Displays the set dimming
UVA 0,5 mW/cm ²	Displays the plugged in sensor and the current irradiance
D _{ist} 0,008 J/cm ²	Displays the current dose



Displays the target time. After this time, the irradiation is terminated.



When a maximum dose is set, the target dose is set. When the dose is reached, the irradiation is terminated.



The progress bar shows the current progress

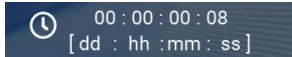

Displays the current irradiation time



Irradiation is canceled. The abort must be confirmed again.

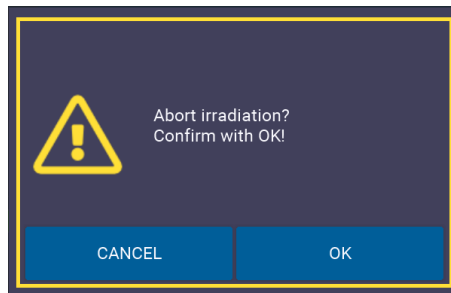

Radiation is paused. The pausing must be confirmed again.

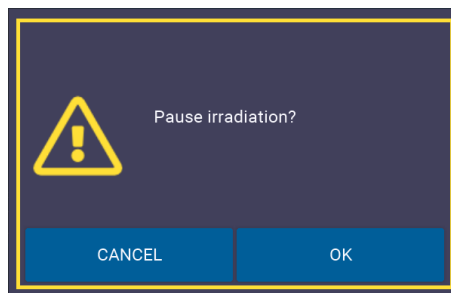

After the irradiation is paused, an orange frame appears around the display.

The lamps are switched off, the dose or time is paused, the door can now be opened.

If it is set that a sensor is activated for both lamp groups, it will only be displayed in the corresponding lamp group.

12.4.1 Display irradiation

This display shows the various settings of the individual lamp groups. In this example, a time is specified after which the irradiation is ended. If a maximum dose is set, only the should and is display changes.

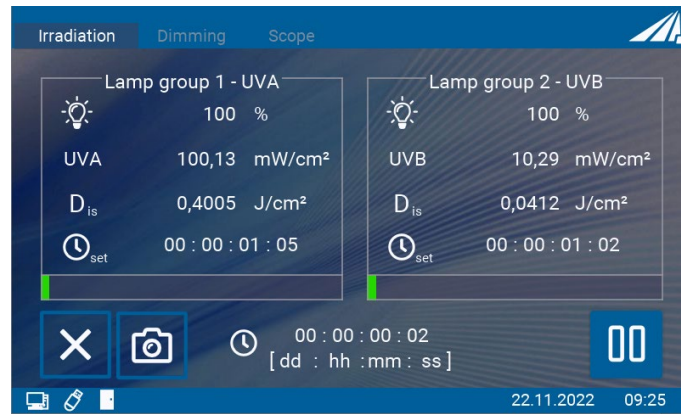

12.4.2 Dimming display

In the Dimming display, the individual lamp groups can be dimmed independently of each other. Adjustment in individual steps is possible with a single click. Quick adjustment by holding the button.



12.4.3 Scope display

This display is used to graphically show the progress of the irradiation.

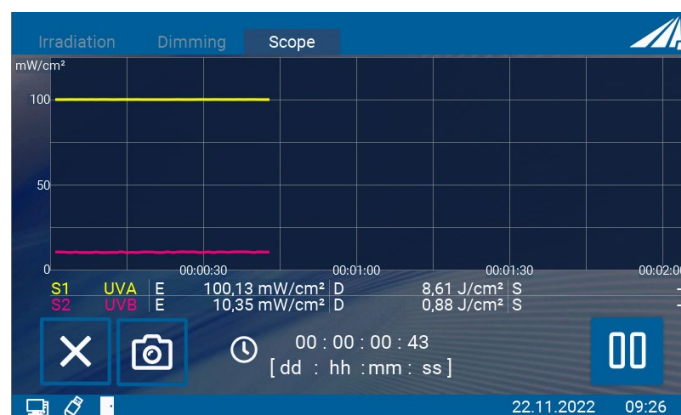

Here the symbols mean:



Display of the sensors and the assigned colors

12.5 After irradiation

The end of the irradiation is indicated by the full green progress bar and the display "FINISHED".

The current values can now be read off.

In addition, it is possible to restart the irradiation with the same settings or return to the main screen.



Back to the main screen



Start irradiation again with the same values

12.6 Data recording

Measurement data can either be recorded to a USB stick or output via USB.

The measurement data files are saved as CSV files. CSV stands for comma-separated-values. A CSV file stores tabular data (numbers and text) in plain text. CSV is a simple file format that is supported by many programs and can be opened with a spreadsheet such as Microsoft Excel or OpenOffice.org Calc.

In the following, the content of the lines is explained using a file excerpt:

```
RMD data file
www.opsytec.de
```

```
[RMD Info]
RMD Touch 5
Firmware1 .0.0518
Series N. 00101
Type 814405
Manu.Date11 .01.2021
```

Information about the measuring device used

```
[Measurement information]
Measurement modeTiming
time interval 60 s
Averaging 0.25s
File name 210413\130217.csv
Decimal separator , [comma]
```

The settings used during data recording.

```
[CH1 Info]
Sensor typelfach , LUX, RM-Digital
Sensor
```

Information about the sensors used.

```
Type                814461
Serial number        00135
Calibration date10   .05.2019
Unit                 klx
Wavelength range380 - 780 nm
Measuring range0-2000 klx
```

```
[CH2 Info]
Sensor type1x , UV-C, RM-Digital Sensor
Type                814410
Serial number        00115
Calibration date10   .05.2019
Unit                 W/cm2
Wavelength range200 - 280 nm
Measuring range0-2000 mW/cm2
```

```
***File open***01.01. 201909:42:28
```

```
*****Measurements *****
```

Date [DD.MM.YYYY]	Time [HH:MM:SS]	CH1: LUX [klx]	CH2: UVC [W/cm2]	Can
01.01. 201909:42:	280,	33900,	339022,	422,6
01.01. 201909:43:	280,	3400,	679022,	522,6
01.01. 201909:44:	280,	3401,	019022,	522,6
01.01. 201909:45:	280,	33901,	358022,	422,6
01.01. 201909:46:	280,	33901,	697022,	522,6
01.01. 201909:47:	280,	33902,	036022,	522,6
01.01. 201909:48:	280,	33902,	375022,	522,6

```
***File closed*** 01.01.201909 :49:27
```

12.7 User settings

The "User settings" area can be accessed via the cogwheel symbol or via the main menu. Various system settings can be made here.

12.7.1 Sensors and chamber factors

In the Sensors menu item, various settings can be made for the sensors.

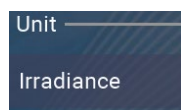
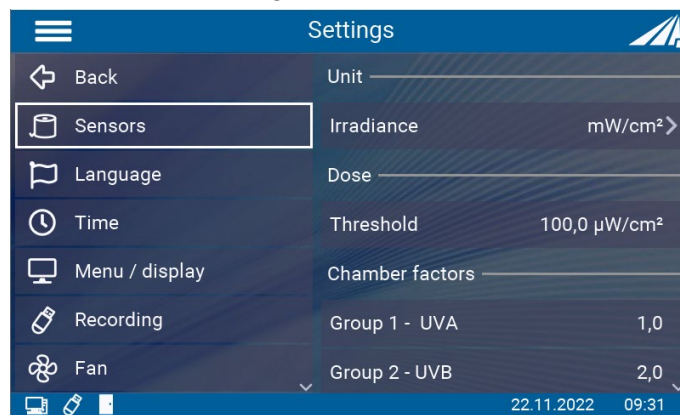

The unit of irradiance can be changed here.

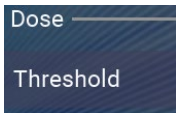

The irradiation dose is automatically summed up if it is higher than the threshold irradiance. This minimizes possible small offset errors.

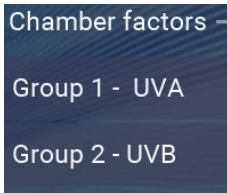

The chamber factor is used to calculate and output the irradiance at a different position (than the sensor position).

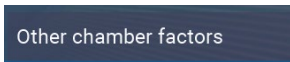

Further chamber factors (for unconnected) sensors can be seen here.

The chamber factor is used to calculate and output the irradiance at a different position (than at the sensor position). Thus, the displayed irradiance is the same even if measured at the lateral sensor position.

The chamber factor has already been determined and preset by the manufacturer. See the technical documentation in the appendix.



This setting should be tested for different specimen sizes / specimen heights. The initial setting was made centrally, approx. 35 mm above the specimen level (chamber bottom).

If you want to use the irradiance at any position, proceed as follows:

- Set as sensor factor: 1.0000
- Measure the irradiance at (any) position 1.
- Measure the irradiance at the sensor position.
- Divide the irradiance at position 1 by the irradiance at the sensor position. The result is the sensor factor.
- Set the sensor factor.



Use the key to add a digit.

- Repeat the setting if you use several sensors / lamp groups.

12.7.2 Language

This menu item allows switching the system language between German and English and switching the decimal separator used between comma and dot. Analogous to the decimal separator, the thousands separator also changes.

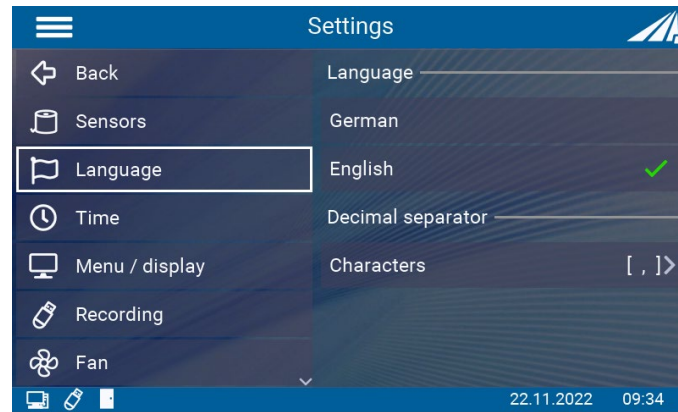

12.7.3 Time

The RMD Touch has a real-time clock. You can set the real-time clock in the "Date / Time" menu.

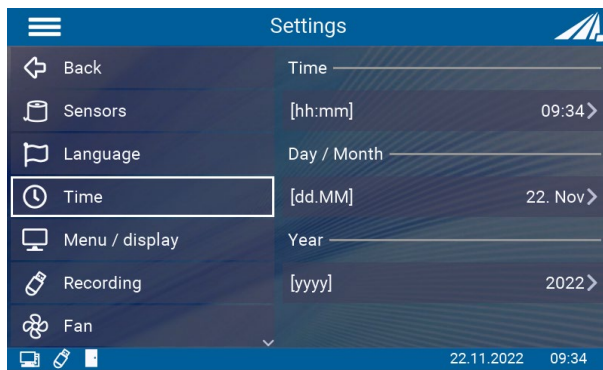

The real-time clock is set automatically by connecting the device to the PC software or can be set in the Time menu. Setting the time may be necessary e.g. after a firmware update or after resetting to factory settings.



Note

The real-time clock is supported by an internal battery for a short time. Leave the power cord plugged in to conserve the battery.

Check the settings after a leap day / leap second or after changing the summer/winter time.

12.7.4 Menu/Display

The screen brightness can be set here.

In addition, it is possible to choose a password to lock different areas of the settings menu.

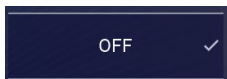
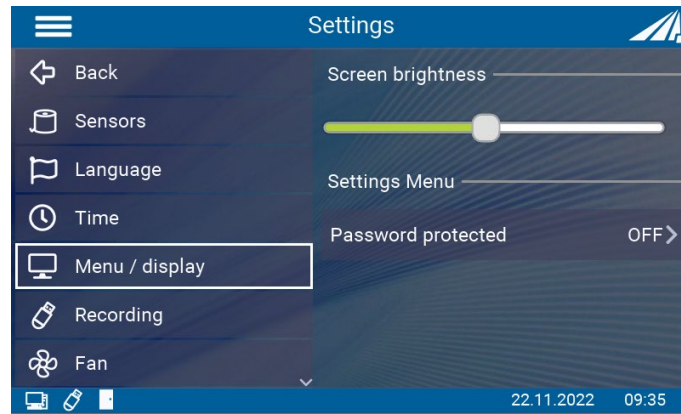

no password protection, all menus are active



All settings are password protected

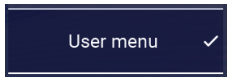

only the "User menu" is password protected. Irradiation and dimming can be changed.

The password is: 7243

12.7.5 Record

The UV-Mat Touch can create a protocol of the irradiation. There are various setting options here.

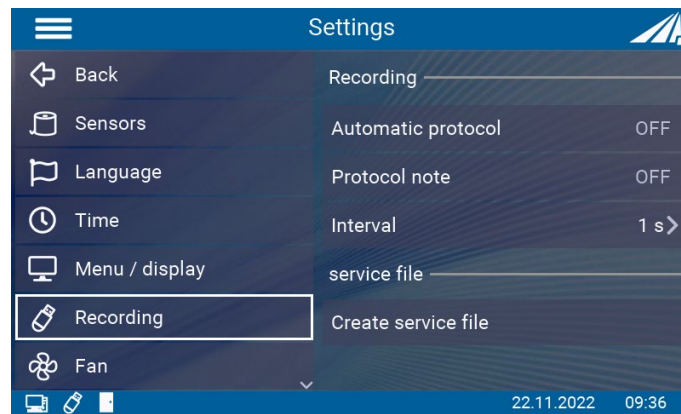

A protocol is created for each irradiation and saved on the USB stick



If on and automatic protocol is on, a note can be typed in before each irradiation



Measured values are saved at the set interval

A service file can also be created here, which supports troubleshooting by the manufacturer

12.7.6 Fan

It is possible to adjust the fan during and outside irradiation. Thus, the volume alone can be reduced.

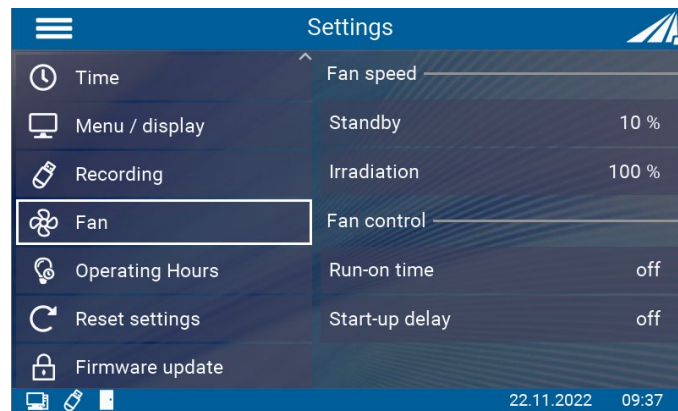

Fan power in standby / without irradiation



Fan power during irradiation



The fan continues to run for the set time after irradiation with the irradiation power



The fan runs for the set time after the start of irradiation still with the standby power

12.7.7 Operating hours

In this menu item, the operating hours of the lamp can be reset. This is necessary when the lamps are replaced with new ones.

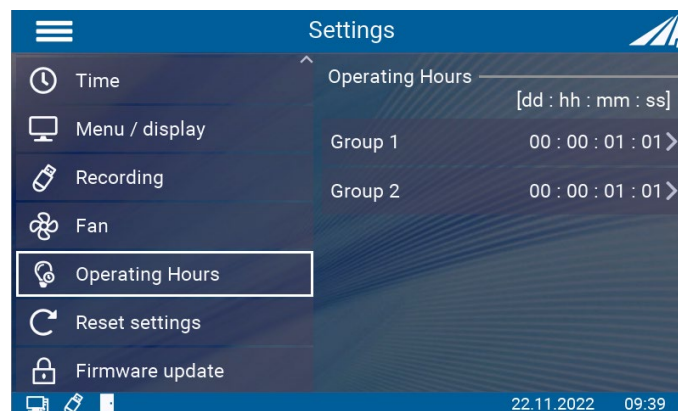

12.7.8 Reset

By confirming, the device is reset to its original settings and restarted. Afterwards, the time must be set again. The switch responds with a long click.

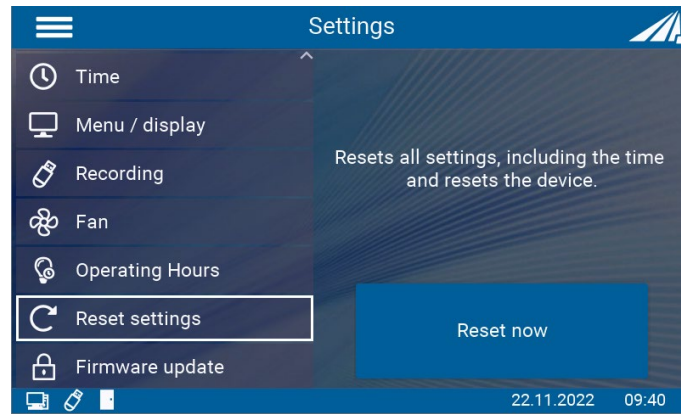

12.7.9 Firmware update

The firmware of the device can be updated with a Windows PC.

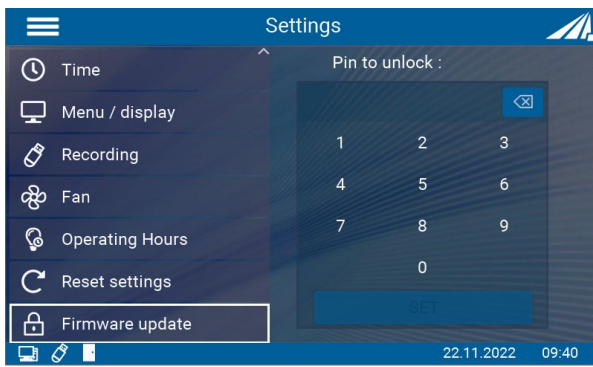

Please contact the manufacturer for this.

12.8 Information

Sensor-specific and device-specific information can be called up under the Information menu item. Only connected sensors are visible in the menu.

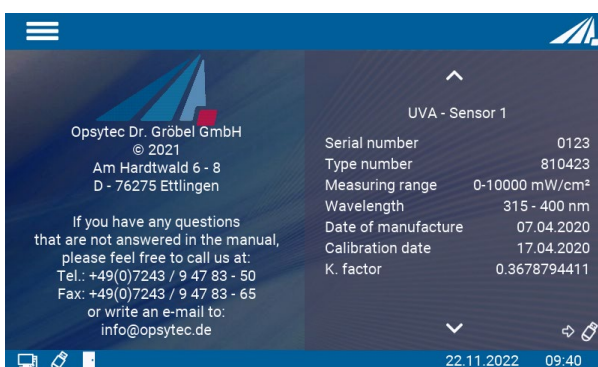

Display of sensor information. If no sensor is connected, this menu item is not displayed.



Display of information about the UV-MAT Touch.

12.9 Error messages

The system issues various error messages. It is possible to react to them in different ways.

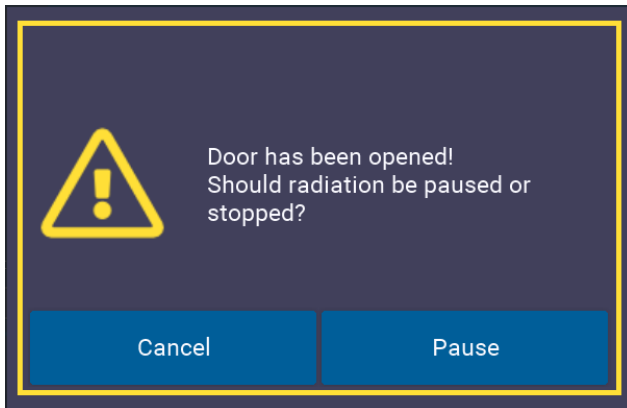

During irradiation, the door was opened.

Irradiation is automatically interrupted and the lamps are switched off.

Cancel: Irradiation is canceled and the control returns to the main screen.

Pause: Irradiation is paused and can be resumed with the door closed.



An attempt has been made to start irradiation even though the door is still open.

Previous: Control returns to the main menu

OK: Irradiation is started when door is closed.

13 USB logging* and REMOTE operation*.

The UV-MAT automatically transmits all data when USB is set to active. The communication takes place as ASCII communication.



Communication is available after initialization.
Depending on the version, initialization may take a few seconds.

Definitions:

- Baud rate: 115200 baud
- Parity: None
- Data bits: 8
- Stop bit: 1

With the USB Active setting, the UV-MAT sends status information at regular intervals, e.g. every second. The following software gives an example of the data acquisition functions:

The screenshot shows the 'COM Log - Version 1.4' software interface. The left panel contains settings for the communication port (COM3, 115200 baud, 8 data bits, None parity, One stop bit) and control buttons (Save setup, Disconnect, Record mode, Clear view, TX Mode). The right panel displays the communication protocol data, including sensor information (Sensor 1: UVA+, Serial Number: 00121, Typ Number: 814445, Calib. date: 03.12.2019, Calib. factor: 0.00204, Calib. unit: mW/cm2, Amplifiers f.: 101.0, amp. up limit(S.L.Op2): 28.08.2020 14:53:06 0.9, amp. down limit(S.L.Op1): 0.007, Wavelength range: 330nm-455nm, Offset 1: 0.007, Offset 2: 0, Manu. Date: 02.04.2019, MemoryNR.: 1, OpHours: 22 h, OpH. Kalib: 22 h, OpH. Meas.: 20 h, Min. Temp.: 20.2 C, Max. Temp.: 32.0 C) and a data acquisition table.

DDD:HH:MM:SS	Sensor 1	Power CH1 [%]	Irradiance [mW/cm2]	Dose [J/cm2]	Sensor 2	Power CH2 [%]
28.08.2020 14:53:06	000:00:00:00 UVA+ 99	0.00	0.0000	UVA 5	0.00	0.0000
28.08.2020 14:53:08	000:00:00:01 UVA+ 99	0.84	0.0004	UVA 5	1.33	0.0007
28.08.2020 14:53:09	000:00:00:02 UVA+ 99	1.47	0.0019	UVA 5	2.41	0.0031
28.08.2020 14:53:10	000:00:00:03 UVA+ 99	1.46	0.0034	UVA 5	2.41	0.0055
28.08.2020 14:53:11	000:00:00:04 UVA+ 99	1.46	0.0048	UVA 5	2.40	0.0079
28.08.2020 14:53:12	000:00:00:05 UVA+ 99	1.45	0.0063	UVA 5	2.39	0.0103
28.08.2020 14:53:13	000:00:00:06 UVA+ 99	1.45	0.0077	UVA 5	2.40	0.0127
28.08.2020 14:53:14	000:00:00:07 UVA+ 99	1.45	0.0092	UVA 5	2.39	0.0151
28.08.2020 14:53:15	000:00:00:08 UVA+ 99	1.46	0.0107	UVA 5	2.40	0.0175
28.08.2020 14:53:16	000:00:00:09 UVA+ 99	1.46	0.0121	UVA 5	2.40	0.0199
28.08.2020 14:53:17	000:00:00:10 UVA+ 99	1.46	0.0136	UVA 5	2.40	0.0223
28.08.2020 14:53:18	000:00:00:11 UVA+ 99	1.46	0.0150	UVA 5	2.40	0.0247
28.08.2020 14:53:19	000:00:00:12 UVA+ 99	1.46	0.0165	UVA 5	2.40	0.0271
28.08.2020 14:53:20	000:00:00:13 UVA+ 99	1.46	0.0179	UVA 5	2.40	0.0295
28.08.2020 14:53:21	000:00:00:14 UVA+ 99	1.46	0.0194	UVA 5	2.41	0.0319
28.08.2020 14:53:22	000:00:00:15 UVA+ 99	1.46	0.0209	UVA 5	2.41	0.0343

Remote operation is required if the UV-MAT and the BSL-04 are to be controlled via a USB interface. The remote mode can be selected via the switch on the back of the UV-MAT. In remote mode, operation on the device is not possible.



Remote operation is selected by the switch on the back. **The switch must be active when starting the UV-MAT.**

After successful initialization, the remote operation is displayed as follows:



13.1 Software installation

For the installation please proceed as follows:

- 1.) If necessary, disconnect the UV-MAT from the PC.
- 2.) Start the installation with "setup.exe" in the master data of the software CD. Follow the instructions of the installation program.



The driver installation is automatically executed as a virtual COM port.

- 3.) After completing the installation, connect the UV-MAT to the PC. The UV-MAT is integrated as a virtual, serial interface. The driver installation is carried out automatically under Windows 7.

13.2 Establish connection with the PC

Connect the UV-MAT to the PC and switch it on. The message "REMOTE" appears on the screen.

Once the UV-MAT is connected to the PC, it does not respond to each keystroke. Disconnect the connection with the PC and the UV-MAT continues to work autonomously.

14 Software - UV-MAT Control for UV-MAT Touch*

The "UV-MAT Control" software is used to control the irradiation chamber with UV-MAT using a PC. The software enables:

- Switch channels on and off
- To change the power (of the channels)
- To use a timer for the channels
- One dose to use for the channels
- Save and load settings as presets (software side)

The software is divided into several areas. At the bottom of the software there is a status bar with various notes.

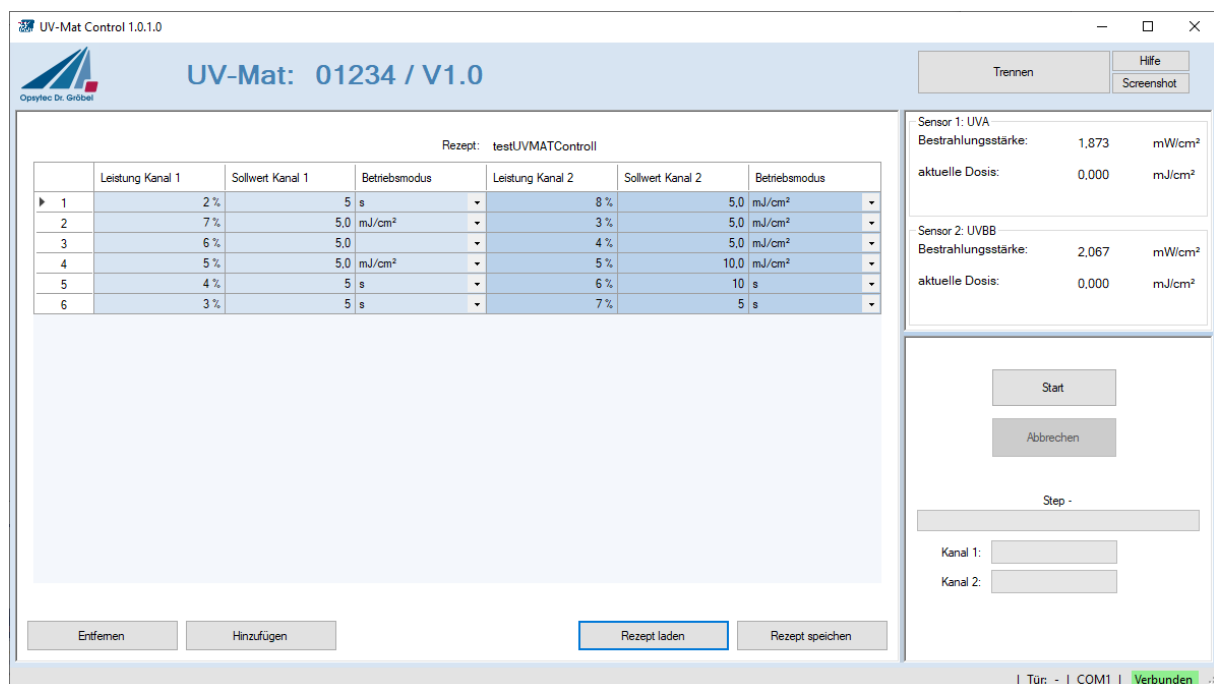

The functions are described below:

Top

UV-Mat: 01234 / V1.0

Displays the serial number of the connected UV MAT

Trennen

Connects or disconnects the UV-MAT from the PC and displays the connection status:

- Connected disconnects → the connection to the UV-MAT
- Not connected connects → the UV-MAT

Screenshot

Creates / saves a screenshot for the documentation of the irradiation

Hilfe

For more information

Equipment control

The left area of the software is used for control and monitoring. Here a summary table is displayed with all outputs, times and dose values for the channels.

Rezept: testUVMATControll

	Leistung Kanal 1	Sollwert Kanal 1	Betriebsmodus	Leistung Kanal 2	Sollwert Kanal 2	Betriebsmodus
▶ 1	2 %	5 s	▼	8 %	5,0	mJ/cm ² ▼
2	7 %	5,0	mJ/cm ² ▼	3 %	5,0	mJ/cm ² ▼
3	6 %	5,0	▼	4 %	5,0	mJ/cm ² ▼
4	5 %	5,0	mJ/cm ² ▼	5 %	10,0	mJ/cm ² ▼
5	4 %	5 s	▼	6 %	10 s	▼
6	3 %	5 s	▼	7 %	5 s	▼

The table is used to select the channels, to display the currently set power intensity and to display the channel status.

From the right side there are various control functions for the irradiation together with the start / cancel button.

Sensor 1: UVA

Bestrahlungsstärke: 0,369 mW/cm²

aktuelle Dosis: 1,930 mJ/cm²

Sensor 2: UVBB

Bestrahlungsstärke: 1,029 mW/cm²

aktuelle Dosis: 3,742 mJ/cm²

Start

Abbrechen

Step 1 / 6

Kanal 1: Zeit

Kanal 2: Dosis

The progress of the process is displayed in the table:

	Leistung Kanal 1	Sollwert Kanal 1	Betriebsmodus	Leistung Kanal 2	Sollwert Kanal 2	Betriebsmodus
▶ 1	2 %	5 s	▼	8 %	5,0	mJ/cm ² ▼
2	7 %	5,0	mJ/cm ² ▼	3 %	5,0	mJ/cm ² ▼
3	6 %	5,0	mJ/cm ² ▼	4 %	5,0	mJ/cm ² ▼
4	5 %	5,0	mJ/cm ² ▼	5 %	10,0	mJ/cm ² ▼
5	4 %	5 s	▼	6 %	10 s	▼
6	3 %	5 s	▼	7 %	5 s	▼

The process step is defined in the table. Example:

Channel 1 2% power for 5 s, channel 2 8% power for a dose of 5 mJ/cm².

Software taskbar

At the bottom of the software there is a bar with various functions: The right area of the bar is used to display errors and messages

Errors and messages appear in the display for 3 s, errors are highlighted in red. The last ten messages are displayed here when the mouse pointer hovers over them.

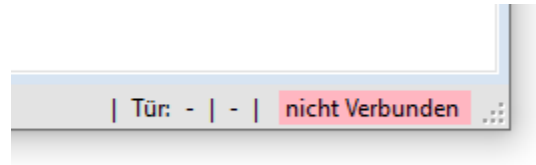

The left area is used to display congestion messages

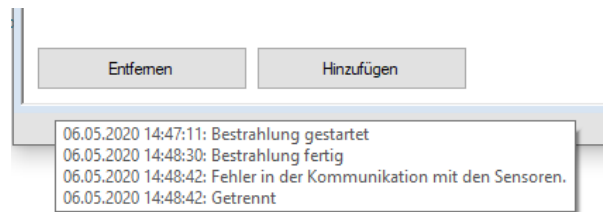

14.1 Working with the software

Make sure that the UV-MAT is connected to the PC and the BS-03 is switched on. Please note that the device must be in remote mode, so that the display reads REMOTE.



Remote operation is selected by the switch on the back. **The switch must be active when starting the UV-MAT.**

When opening the software, one the UV-Mat connects automatically.

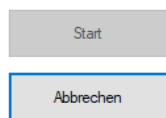

Pressing Start starts the irradiation with the set sequence.

Pressing Cancel cancels the irradiation with the set sequence.

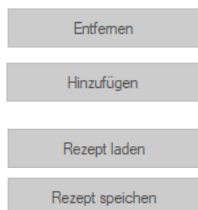

Here steps can be removed by marking a line or new steps can be inserted.

Here preset "Preset" / "Recipes" can be loaded and saved

Presets:

Presets are saved as *.csv file and can be viewed in an editor if necessary. Example:

```
testUVMATControll.csv
Date (dd.mm.yyyy); 29.48.2020
Software version number; 1.0.0.0
Number of Steps; 6

*****
power channel 1; setpoint channel 1; operating mode 1; power channel
2; setpoint channel 2; operating mode 2;
*****
2;5;s;8;5;mJ/cm2;
3;5;s;7;5;s;
4;5;s;6;10;s;
5;5;mJ/cm2;5;10;mJ/cm2;
6;5;mJ/cm2;4;5;mJ/cm2;
7;5;mJ/cm2;3;5;mJ/cm2;
*****
```

15 Maintenance

Switch off the irradiation chamber with the power switch. Pull the power plug out of the socket.

The BSL-04 is a combined system that requires only cleaning and recalibration as preventive maintenance.

For cleaning, we recommend to do it only on request and not regularly, because the side mirrors and the sensor surface are sensitive to scratches.

Please use isopropanol in a UV-IR grade to clean the sensor(s).

The mirrors are cleaned ONLY AS NEEDED with compressed air or isopropanol and a very soft paper towel.

The glass plates are cleaned AS NEEDED with compressed air or isopropanol and a very soft paper towel.

Since it is a combined system, we may need BSL-04 and UV-MAT in case of repair. Some spare parts can be changed by customer. Note, it is not recommended to change parts other than UV-Leds by yourself. The warranty on spare parts is provided only if the service is done by us.

For the recalibration we only need the sensor.

The following table contains some maintenance steps as a recommendation:

	⚠ WARNING
	<p>Danger of injury! Danger of burns! During irradiation, the led temperature can reach approx. 50° C.</p>

	⚠ CAUTION
	<p>Risk of damage</p> <ul style="list-style-type: none"> • Skin grease and dirt are absorbent in the UV and visible spectral range. • Avoid fingerprints on the optical components, sensor surfaces, Leds/Led cover and reflectors. If necessary, clean the components carefully with isopropanol.

No.	Maintenance item	Procedure	Recommended frequency
1	General inspection and cleaning of the machine	Cleaning the underside of the interior of the irradiation chamber. Dust extraction, rust inspection, check for peeled paint, leaks, broken switches and damaged covers, replace if necessary.	Semiannual
2	Sensor check	1. check sensors, must be free of dirt, otherwise clean / recalibrate.	Monthly
3	Cleaning optical components	Visual inspection of mirrors. The mirrors must be clean. Minor soiling can be accepted as the mirrors are sensitive to scratches. Cleaning only as needed.	Monthly
		If cleaning is required, use compressed air or isopropanol (UV-IR grade) and a very soft paper towel. Soft, clean mirror from left to right, top to bottom. Must be free of cracks and dirt, otherwise replace with new.	According to demand
4	Testing the door contact	Verify and check the door contact by its physical appearance. Replace it if necessary.	Semiannual
5	Intensity check	Check and determine the actual irradiance using a UV sensor (must be calibrated).	Monthly
6	Change Leds	Replace UV-Leds if the irradiance is not high enough.	According to demand
7	Calibration	1. check calibration by comparison measurement or calibration date.	Annual
		2. send the sensor to the manufacturer if recalibration is required.	
8	Checking the wiring	Check all cable connections for possible damage or loose contacts. Replace them if necessary.	Every 6weeks
9	Cleaning	Clean the machine housing (outside) with a dry cloth to remove dust and dirt.	Semiannual

Only carry out cleaning work on the sensor as required. This will give you the best possible stability. Clean only with isopropanol (UV-IR-GRADE), with oil-free compressed air or with clean, lint-free cloths.

Wear clean, lint-free gloves.

Apply the detergent only to the cloth, moisten only.

The cleaning agent could get inside and cause property damage.

Wipe the surfaces with little pressure, in a circular motion.

Then remove all residues of the cleaning agent.

CAUTION	
	<p>Risk of damage</p> <ul style="list-style-type: none">• Skin grease and dirt are absorbent in the UV and visible spectral range.• Avoid fingerprints on the optically active sensor surface. If necessary, clean the components carefully with isopropanol.

15.1 Insert sensor and sensor exchange

Replace the base plate and screw it back into place.

Mount the sensor in the left sensor holder in the irradiation chamber.

Remove the sensor caps.

Feed the sensor cable through the cable gland on the back of the irradiation chamber.

Connect the sensor to the UV-MAT.

⚠ WARNING	
	<p>Risk of injury when touching live parts</p> <p>Before opening the irradiation chamber, disconnect all components from the supply voltage and check that no voltage is present.</p>

15.2 Calibration

We recommend having the sensors used calibrated by the manufacturer every year to ensure accurate measurement results.

15.3 LED insertion and LED replacement

Please contact the manufacturer for this.

	⚠ WARNING
	<p>Risk of injury when touching live parts</p> <p>Before opening the irradiation chamber, disconnect all components from the supply voltage and check that no voltage is present.</p>

15.4 Error / malfunction

The following notes and error messages are intended for the user. The notes are intended to help ensure proper operation. For this purpose, possible causes and remedies are indicated.

Function / Display	Meaning	Actions
Fan does not run after irradiation is switched on	No supply voltage	Check cables and connections. Check supply voltage.
System does not respond	Wrong mode, shows REMOTE	Disconnecting the USB cable
The irradiance is too low	Leds aged	Replace Leds
	Leds dirty	Cleaning (e.g. with ISOPROPYL)
	Leds not correctly parameterized / dimmed	Set power (2-100%)
	Sensor error	Check sensor or recalibrate

16 Spare parts



Contact for replacement orders:

Opsytec Dr. Gröbel GmbH
 Am Hardtwald 6-8
 76275 Ettlingen
 Germany
 Phone +49 - 7243 - 94 783 - 50

Visit us on the Internet: www.opsytec.de

The following spare parts are available for your system:

Designation	Item number
Air filter set	BSL-04-IF
Air inlet cover	BSL-04-AIC
Left inner side mirror	BSL-04-BM
Rear interior mirror	BSL-04-RM
Right interior mirror	BSL-04-RM
Air outlet fan	BSL-04-AOF
Air outlet cover	BSL-04-AOCS
Base plate	BSL-04-BP
Front door with interior mirror	BSL-04 -door
Door contact	860801L-DC
UV-MAT	860 920L + serial number
Sensor	See sensor type
Recalibration of the sensor	710001
Sensor recalibration, DAKKS	17025
Other parts	Upon request

17 Declaration of Conformity



Manufacturer:	Company name: Opsytec Dr. Gröbel GmbH Street: Am Hardtwald 6-8 Place: 76275 Ettlingen Country: Germany
Authorized person for the compilation of technical documentation:	Company name: Opsytec Dr. Gröbel GmbH Street: Am Hardtwald 6-8 Place: 76275 Ettlingen Country: Germany
Product:	Irradiation chamber BSL-04 with control unit UV-MAT and sensor(s)
Type designation:	BSL-04
Type number:	860 904L XXXX 860 920L XXXX 814 4XX XXXX

The manufacturer hereby declares that we have developed, designed and produced the above-mentioned product(s) under our sole responsibility and that the product complies with the following standard(s) or guideline(s) in this declaration:

2014/35/EU

"Directive of the European Parliament and of the Council on the harmonization of the laws of the Member States relating to the provision of electrical Equipment for use within certain voltage limits on the market (Low Voltage Directive)".

2014/30/EU

"Directive of the European Parliament and of the Council on Electromagnetic Compatibility (EMC Directive, recast)".

2015/863/EU

"Directive of the European Parliament and of the Council on the restriction of the use of certain hazardous substances in electrical and electronic equipment (ROHS Directive III)".

The compliance of the designated product with the provisions of the Directive is demonstrated by full compliance with the following standards:

DIN EN 61326-1:2013-07 Electrical equipment for measurement, control, and laboratory use - EMC requirements - Part 1: General requirements.

Ettlingen, 27.06.2023

gez. Dr. Mark Paravia

This document is valid without signature if the person responsible for the release is named in clear writing.

