

Irradiation Chamber BSM-03

Manual

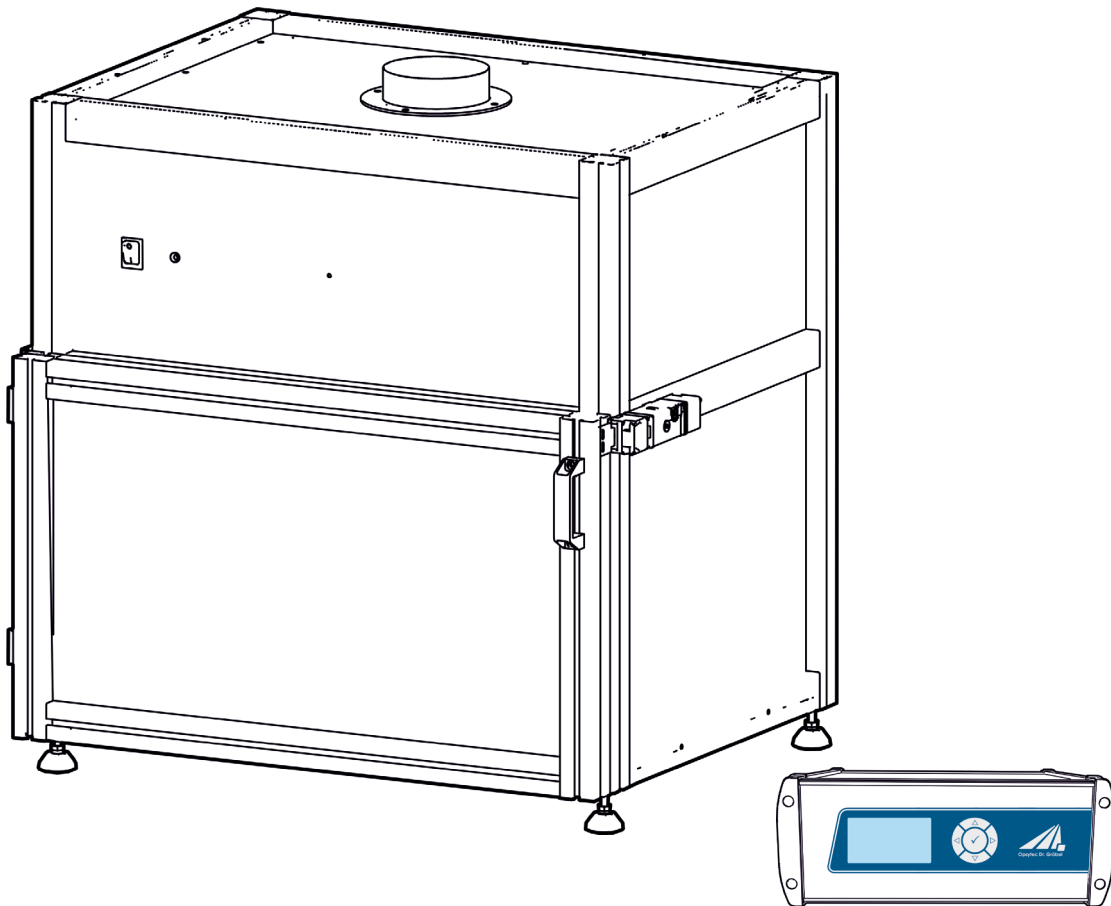

Version 1.3.0

Opsytec Dr. Gröbel GmbH
Am Hardtwald 6-8
D-76275 Ettlingen

Phone: +49(0)7243 / 9 47 83-50
Fax: +49(0)7243/ 9 47 83-65
info@opsytec.de

1 Table of Contents

1	Table of Contents	2
2	Preface	4
3	Quick start guide	5
4	Directives and Norms	6
5	Identification	7
5.1	Manufacturer, Ordering of Spares and Customer Service	7
5.2	Change History	7
5.3	Copyright	7
5.4	Identification of the Device.....	7
5.5	Intended Use	8
5.6	Foreseeable Misuse	9
5.7	Legal Information	10
5.7.1	Limitation of Liability	10
5.7.2	Declaration of conformity.....	10
5.7.3	Warranty Terms.....	10
6	General	11
6.1	Information about this Manual	11
6.2	Information about the Symbols	12
6.2.1	Safety Instructions	12
6.2.2	Prohibition Signs	12
6.2.3	Warning Signs	13
6.2.4	Attention	13
6.2.5	Fire Protection Sign.....	14
6.2.6	Rescue Sign	14
6.2.7	Optional functions.....	14
6.3	Owner/Operator Information	15
6.4	Personnel Requirements	16
6.4.1	Qualifications	16
6.4.2	Electrically skilled person	17
6.4.3	Qualified person	17
6.4.4	Operators	17
6.4.5	Training and Qualification of Personnel	17
6.5	Personal Protective Equipment	18
6.5.1	Protective Gloves	18
6.5.2	Protective Goggles	18
6.5.3	Safety Boots	18
7	Safety Information and Residual Risk	19
7.1	General	19

7.2	Safety Information Concerning Normal Operation	20
7.3	Radiation Safety	23
7.4	Safety Information Concerning Service and Repair Work.....	24
8	System Description	26
9	Commissioning	29
10	Operating	30
10.1	Switching on the system:	30
10.2	Exposure:	30
10.3	Switching off the system:	32
11	UV-MAT operation.....	33
11.1	Lamp on / off.....	34
11.2	Power Modification	35
11.3	Start / Stopp Radiation.....	36
11.4	Operation mode	36
11.4.1	Timer mode	37
11.4.2	Dose controlled mode	37
11.5	Setup menu	39
11.5.1	Language	39
11.5.2	Version	39
11.5.3	intern.....	39
11.6	Internal settings menu	39
11.6.1	Sensor factors	40
11.6.2	Calibration*	40
11.6.3	Upper and lower limit / each spectral range.....	41
11.6.4	Safety time	41
12	Maintenance	42
12.1	Lamp Replacement for Version 2020 (from irradiation chamber)	42
12.2	Lamp Replacement until version 2020 (from the top)	44
13	Troubleshooting.....	50
14	Technical Data.....	51
15	Spare Parts	55
16	Declaration of Conformity.....	56

2 Preface

Dear Customer!

Thank you for choosing a product manufactured by us!

Please take your time to read this manual carefully. Please pay special attention to the safety instructions.

This is the condition for safe handling and safe operation of the system and its components.

If you have any questions that you do not find answered in this manual, please call us and we will be pleased to assist you. In addition, we always welcome any suggestions or proposals for improvement.

Our products undergo constant advanced development; therefore there may be minor differences between your system and the illustrations given in this Operating Manual.

© 2021

Opsytec Dr. Gröbel GmbH

Am Hardtwald 6-8

D – 76275 Ettlingen

Tel.: +49(0)7243 / 9 47 83-50

Fax: +49(0)7243 / 9 47 83-65

info@opsytec.de

All rights reserved. Re-printing, also extracts, only permitted with written consent of Opsytec Dr. Gröbel GmbH.

This is a translation of the original operating manual.

3 Quick start guide

The quick guide should demonstrate the installation and some of the system functions to trained personnel. You will find the detailed instructions on page 29. Please pay special attention to the safety instructions given in the complete manual.

Commissioning:

- Unpack all components and remove the packaging materials.
- The BSM-03 is delivered with a preassembled lamp. You don't need to install the lamp.
- Connect the compressed air for the shutter at the rear of the ballast unit.
- Connect an exhaust hose at both air outlets.
- The BSM-03 uses a ventilation system. Make sure that the air inlets are not covered.
- Connect the external UV MAT with the BSM-03.
 - Mount the sensor in the left-hand sensor holder inside the irradiation chamber.
 - Remove sensor caps.
 - Route the sensor cable through cable feedthrough in the rear side of the irradiation chamber.
 - Connect the sensor with the LedControl
- Switch on the system by means of the switch on the front side of BSM-03

Operation:

- Switch on the irradiation chamber by means of the power switch. This immediately ignites the UV lamp. Wait 10 minutes until the lamp has reached the operating temperature.
Open the front door of the irradiation chamber and place the objects to be irradiated in the irradiation chamber.
- Make sure that the built-in sensor is not covered for dose-controlled radiation.
- Close the front door of the irradiation chamber, otherwise the shutter won't open.
- Choose Operation mode: continuous irr. (irradiation), timer or dose*
- If necessary, check the irradiation intensity and use ▽ and △ keys to adjust the radiation intensity and check the sensor factor (see chapter 10.5)
- Start the irradiation by UV-MAT. At the end of the exposure open the front door of the irradiation chamber and carefully remove the irradiated objects.
- Switch off the lamp and let the system cool down. Then switch of the system.



Information on safety instructions can be found on page 19.

Information on commissioning can be found on page 29.

Information on how to operation can be found on page 30.

4 Directives and Norms



The system is machinery under Annex II A of the Machinery Directive and is therefore delivered with a declaration of conformity and with a CE mark (in accordance with the Machinery Directive).

Directives	
EC Directives	06/42/EC (Machinery) (partially observed) 2014/30/EC (EMC) 2014/35/EC (Low voltage)
Harmonized standards	
EN ISO 12100:2010	Safety of Machinery – General Principles for Design Risk Assessment and Risk Reduction
EN 61000-6-2:2005	Electromagnetic Compatibility (EMC) – Part 6-2: Immunity for Industrial Environments
EN 61000-6-4:2007 + A1:2011	Electromagnetic Compatibility (EMC) – Part 6-4: Emission Standard for Industrial Environments

5 Identification

5.1 Manufacturer, Ordering of Spares and Customer Service

Opsytec Dr. Gröbel GmbH
 Am Hardtwald 6-8
 D – 76275 Ettlingen
 Tel.: +49(0)7243 / 9 47 83-50
 Fax: +49(0)7243 / 9 47 83-65
 info@opsytec.de
 www.opsytec.com

5.2 Change History



We reserve the right to make changes in content. Opsytec Dr. Gröbel GmbH is not liable for any errors in this documentation. No liability shall be accepted for indirect damages arising from the delivery or use of this documentation, in as far as this is legally permissible.

Version	Changed by	Date	Change
1.0.0	Rau	20.11.2013	Release
1.0.1	Paravia	17.01.2016	Changed UV-MAT
1.1.0	Klein	07.04.2017	Changed Images
1.1.1	Paravia	25.07.2017	Layout changes
1.2.1	Paravia	20.11.2017	Air Exhaust, RCD changes
1.3.0	Paravia	15.09.2021	Lamp exchange updated

5.3 Copyright



Opsytec Dr. Gröbel GmbH shall retain the copyright for these operating manual. The operating manual is intended for the owner/operator and his personnel.

Copyright in accordance with DIN ISO 16016:

Reproduction and copying of this document, use and disclosure of its contents are prohibited unless expressly authorized.
 Non-compliance may result in a claim for damages. All rights reserved in case of registration of patent, utility patent, or design patent.
 Contraventions may be subject to prosecution.

5.4 Identification of the Device

For internal use at customer site:

Description of machinery:	Irradiation chamber BSM-03
Year of construction:
Machine No.

Project no.
-------------	-------

5.5 Intended Use

The irradiation chamber BSM-03 is a curing chamber for the laboratory and the manual production as

- Curing adhesives or casting compounds
- Curing varnishes and paints
- Irradiation in biological or chemical applications

The system is exclusively intended for industrial use. It is forbidden to use the devices in explosive environments or for general illumination.

- Installation, commissioning, operation, maintenance and service works must solely be performed by trained and educated, qualified personnel, which observes all safety regulations and standards.
- Responsibility: Damages resulting from unintentional or unauthorized interventions terminate every right, to raise warranty or liability claims against the manufacturer.
- Guarantee exclusion: The use of any non-original parts voids the guarantee.
- Environmental protection: Defect parts, which may contain environmentally harmful substances, must be disposed of accordingly.
- During the operation a high-energy UV and/or visible radiation is generated.
- In cases of ozone-generating lamps OZONE is generated during operation.
- Operation is only permitted in a dry environment. The installation is horizontal.
- The UV lamp must be operated horizontally. The optimum lamp temperature is 600 °C to 1050 °C.
- When working with the irradiation chamber BSM-03 always wear a face shield, safety goggles and gloves.
- Only suitable for the operation in closed rooms.
- Prior to opening, the system must be disconnected from the voltage and it must be checked that there is no voltage present.
- Wear gloves for maintenance, cleaning and exchanging the leds and optical components.
- The system must not be cleaned when in operation.
- The door must not be opened during irradiation. The front door is monitored. Should it be opened during the irradiation, the UV lamp will automatically switch off. Since this is done with a slight delay, the user will possibly be briefly exposed to UV radiation.
- Any other use than the above mentioned, results in damages to the product. Furthermore, it is associated with risks such as short circuits, fire and electric shocks. The entire device must not be changed and/or modified! The safety notes must be observed at all times.

	⚠ CAUTION
	<p>System may fall down! Device damaging and personal injuries are possible</p> <ul style="list-style-type: none">• Always carry the system with two persons.

5.6 Foreseeable Misuse

The following is considered foreseeable misuse:

- Operation of the device without safety devices and equipment.
- Activities of uninstructed personnel on the device.
- Non-compliance with the operating instructions of the owner/operator.
- Ignoring of the operating manual.
- Any other use outside the intended specified use.

5.7 Legal Information

5.7.1 Limitation of Liability

All the information in this manual was compiled with consideration of the currently valid standards and regulations, of the technical standard and our long-standing knowledge and experience.

The manufacturer shall not be liable for damage in the event that:

- This manual is ignored,
- The device is improperly used,
- Untrained personnel is deployed,
- Untrained personnel operates the machine incorrectly,
- Unauthorized modifications are made,
- Technical changes are made,
- Non-approved spare parts are used.

We shall not be liable for common faults of the device caused by power outage or failure of the control system.

The actual scope of delivery may be different than the explanations and pictures in this manual in case of special versions, when additional options are ordered or due to the latest technical changes.

The obligations agreed in the delivery contract, as well as the legal requirements valid at the time the contract was concluded shall apply.

5.7.2 Declaration of conformity

The declaration of conformity is in the annex or can be requested from the manufacturer.

5.7.3 Warranty Terms

The warranty terms and guarantee conditions are governed by the German Civil Code (BGB). The warranty period is one year unless otherwise agreed in the purchase documents.

6 General

6.1 Information about this Manual

This manual intends to make handling of this system and its components safe and efficient. The manual is part of the system and must be kept in its immediate vicinity where it is accessible for the personnel at any time.

This documentation contains the necessary information for the intended use of the described system. It is intended for technically qualified personnel who have been especially trained for operation, laboratory use, quality assurance, service and repair.

The personnel must have read this manual carefully and understood its content before commencing any work. The basic condition for safe working is observation of all stated safety information and operating instructions in this manual.

Knowledge and technically faultless implementation of the instructions, safety requirements, safety information and warnings are a condition for safety in operation, service and repair. Only qualified personnel has the required professional knowledge to apply the safety requirements, safety information and warnings stated in this operating manual in a general way correctly in a concrete situation.

In addition, the local accident prevention regulations and general safety regulations apply for the area of application of the system.

Illustrations in this manual serve the purpose of general understanding; they may differ from the actual version.

Apart from this manual the instructions for the installed components included in the appendix apply.

This operating manual cannot take any possible case of maintenance into account. If you need further information or if special problems occur that are not treated extensively enough in this manual please request the required information from the manufacturer.



For a simple description, the above mentioned components are collectively referred to as system.

6.2 Information about the Symbols

6.2.1 Safety Instructions

In this manual, safety information is indicated by means of symbols. Safety information is preceded by signal words that indicate the scope of risk.

To avoid accidents and damage to persons or property, always follow the information and act prudently.

Throughout the text, you will find the following pictograms with the following meanings:

	⚠ DANGER
	<p>Imminent danger Possible consequences: death or most serious injuries.</p> <ul style="list-style-type: none"> • Prevention

	⚠ WARNING
	<p>Dangerous Situation Possible consequences: death or most serious injuries.</p> <ul style="list-style-type: none"> • Prevention

	⚠ CAUTION
	<p>Possible Situation Possible consequences: slight or minor injuries. Sometimes also used for warning of material damage.</p> <ul style="list-style-type: none"> • Prevention



Note

Information for use or useful important information

6.2.2 Prohibition Signs



General "Prohibited-sign"

6.2.3 Warning Signs



Warning of optical radiation
(such as UV, IR, or visible radiation)



Warning of hot surface!



Warning of electricity!

6.2.4 Attention

	Wear eye protection!
	Opaque eye protection must be worn!
	Wear a face shield!
	Disconnect mains plug from electrical outlet!
	Disconnect before carrying out maintenance or repair!
	Use hand protection!
	Wear foot protection!

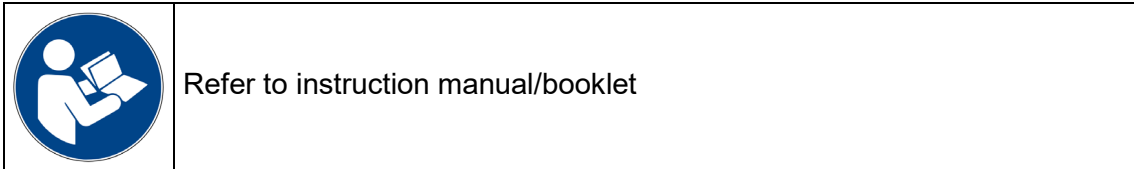

6.2.5 Fire Protection Sign



Extinguishing hose



Fire extinguisher

6.2.6 Rescue Sign



Emergency exit: marking of all emergency exits with this symbol

6.2.7 Optional functions

* Optional functions, not available for every system

6.3 Owner/Operator Information

The System is used in the commercial sector. The owner/operator of the system is therefore subject to the legal obligations concerning work safety.

In addition to the safety information in this manual, the generally applicable regulations valid for the application area of the system concerning safety, prevention of accidents and for protection of the environment must be noted and complied with.

The following applies in particular:

The owner/operator must acquire information about the valid occupational health and safety information and in a risk assessment determine additional hazards incurred due to the special operating conditions at the location of use of the system. He must implement these in the form of operating instructions for operation of the system and specifically for the individual work stations.

The owner/operator is obliged to check during the entire lifetime of the system whether the operating instructions that he generated comply with the current status of the regulations and update them if necessary.

The owner/operator must assign and define the responsibilities for installation, operation, rectification of faults, service and cleaning unambiguously.

The owner/operator must ensure that all personnel dealing with the system have read and understood this manual. Furthermore, he is obliged to provide personnel training in regular intervals and provide information about risks.



The owner/operator must provide the required personal protective equipment for his personnel. Furthermore, the owner/operator is responsible that the system is always in faultless technical condition. To ensure this, the service intervals specified in this manual and in the technical documents for the individual systems must be observed and all safety installations must be checked regularly for function and completeness.



The owner/operator must have all safety devices checked regularly for function and completeness.





The owner/operator must ensure that the operating personnel have knowledge about first aid measures and local rescue installations.

6.4 Personnel Requirements

6.4.1 Qualifications

	 WARNING
	<p>Risk of injury when personnel are insufficiently qualified!</p> <p>If unqualified personnel carries out work on the system or stays in the danger area of the system risks arise that may cause severe injuries and serious material damage.</p> <ul style="list-style-type: none"> • Have all activities carried out only by personnel qualified for the activity. • Keep unqualified personnel away from the danger area.

 	 WARNING
	<p>Risk of injury when touching live parts or hot surfaces</p> <p>Generally, low voltage devices like this system can have dangerous live parts and hot surfaces. All works for transportation, installation, commissioning, start-up and maintenance must be performed by respectively trained and responsible, qualified personnel (in accordance with EN 50110-1 (VDE 0105-100); IEC 60364). Inappropriate behavior can lead to serious injuries or damages.</p> <p>During the irradiation the LED temperature may rise up to approx. 60° C. Caution - risk of burns.</p>

   	 WARNING
	<p>Risk of injury due to UV irradiation</p> <p>When working with the BSM-03 always wear a face shield, safety goggles and gloves.</p> <p>The system is equipped with a UV lamp. There is a risk of photochemical damage to the eyes, retinal damages and erythema. The operating personnel must be trained accordingly.</p> <p>For the protection of the operating personnel: Never look directly at the UV lamp and do not expose your skin permanently to the UV radiation.</p> <p>Note: In case of a malfunction, the UV lamps can still be switched on, even if the BSM-03 does not indicate this. Prior to any works at the system, check that the UV lamps are switched off.</p>

Below, this manual lists the qualifications of the personnel for the various areas of activity:

6.4.2 Electrically skilled person

Due to their professional training, knowledge and experience and knowledge of the relevant standards and regulations, electrically skilled persons are able to carry out work on electrical systems and to recognize and avoid risks independently.

Electrically skilled persons are specially trained for the work environment where they are working and they know the relevant standards and regulations. Electrically skilled persons must fulfil the requirements of the valid legal regulations for accident prevention.

6.4.3 Qualified person

Qualified persons are trained or can be trained by Opsytec Dr. Gröbel GmbH in extended operation and parameterization of the system as well as in execution of preventive service work.

In addition, due to their technical training, knowledge and experience and knowledge of the relevant standards and regulations, they are able to carry out work they have been assigned and to recognize and avoid possible risks independently.

6.4.4 Operators

Operators use and operate the system in the scope of the intended use. They are trained by the owner/operator in the work assigned to them and informed about possible risks.

6.4.5 Training and Qualification of Personnel

In regular instructions and training, operating personnel must be informed about the special risks when working with and handling the system.

The instruction and training should have the following content:

- Hazards when working with the system in normal operation.

- Hazards in connection with service, repair and cleaning activities.

- Conduct to minimize consequences of accidents.

- Conduct in case of accidents.

- Rescue of injured persons.

- Working without personal protective equipment may cause health damage. The company supervisor is instructed to pay attention that personnel are wearing personal protective equipment.

- Particular hazards when working on the electrical system.

Instruction and training must be carried out in regular intervals by the owner/operator. For better tracking, execution of instruction and training should be recorded.

6.5 Personal Protective Equipment

The purpose of personal protective equipment is to protect the personnel from risks that might affect his safety or health when working.

When executing various activities on and with the system, the personnel must wear personal protective equipment. This will be pointed out again in the individual chapters of this manual. Below, personal protective equipment is explained:

6.5.1 Protective Gloves

Protective gloves are used to protect hands from visible and invisible radiation, friction, abrasion, stabs and deep injuries.

6.5.2 Protective Goggles

Protective goggles are used to protect eyes from intense visible and invisible radiation.

6.5.3 Safety Boots

Safety boots are used as protection from heavy parts falling down and slipping on slippery surfaces.

7 Safety Information and Residual Risk



7.1 General



The system is state-of-the-art and has been built in compliance with recognized safety regulations. Nonetheless, its use may constitute risks for life and limb of the operating and repair personnel (service personnel) or third parties or impairments to the machine. Operate the system only when its safety devices are in faultless condition. Disruptions that impair its safety must be rectified at once.





The following safety information must be strictly observed to prevent damage to the machine and personal injury!

	⚠ WARNING
	<p>Risk of injury when personnel do not read the operation manual! Prior to commissioning and operation, read the operation manual completely. Read all safety information and instructions. Negligence concerning safety information and instructions may cause electric shock and/or severe injuries.</p>



7.2 Safety Information Concerning Normal Operation

	 DANGER
	<p>Danger to life</p> <p>Danger to life occurs when the system is operated with defective or absent safety devices.</p> <ul style="list-style-type: none"> The system should be operated only when all protective devices and safety-related installations are present and in working condition. The operator of the machine is obliged to check the safety devices for proper function regularly before production is started.

	 WARNING
	<p>Risk of Fire!</p> <p>An extremely high irradiance, which can ignite combustible materials in cases of permanent radiation, is reached inside at the top of the irradiation chamber. Do not place any combustible material direct under the LEDs and observe the irradiation time and the material temperature.</p>



   	 WARNING
	<p>Risk of injury due to UV irradiation</p> <p>When working with the BSM-03 always wear a face shield, safety goggles and gloves.</p> <p>The system is equipped with a UV lamp. There is a risk of photochemical damage to the eyes, retinal damages and erythema. The operating personnel must be trained accordingly.</p> <p>For the protection of the operating personnel: Never look directly at the UV lamp and do not expose your skin permanently to the UV radiation.</p> <p>Note: In case of a malfunction, the UV lamps can still be switched on, even if the BSM-03 does not indicate this. Prior to any works at the system, check that the UV lamps are switched off.</p>



	⚠ WARNING
	<p>Risk of ozone intoxication!</p> <p>When using ozone-generating lamps, the exhaust air can be enriched with ozone. Ozone is harmful to health, if it is absorbed by the lungs over a prolonged period and in higher concentrations. Therefore, generally avoid inhaling ozone.</p> <ul style="list-style-type: none"> • Ensure an appropriate discharge and treatment of the exhaust air, so that the permissible ozone concentration at the workplace (MAK value) is not exceeded.

 	⚠ WARNING
	<p>Risk of injury when touching hot surfaces</p> <p>The maximum lamp temperature can reach $>1100^{\circ}\text{C}$. There is a risk of skin burns in case of contact. Let the lamp cool down before removing it ($>30\text{min}$).</p> <p>The shutter, lamp and lamp unit becomes hot ($>200^{\circ}\text{C}$) during the operation. Chamber interior becomes hot ($>60^{\circ}\text{C}$) during the operation.</p> <ul style="list-style-type: none"> • Do not touch the shutter, lamp and lamp unit or move it by hand. • Use protective gloves.

	⚠ CAUTION
	<p>Risk of Damage</p> <ul style="list-style-type: none"> • Skin fat and dirt are absorbent in the UV and visible spectral range. The lamps can overheat locally. • Avoid fingerprints on the optically active sensor surface, lamp, and reflectors. If necessary, the components must be cleaned carefully with Isopropyl. • Use safety goggles and gloves when working inside sample room of the BSM-03 irradiation chamber.

	⚠ CAUTION
	<p>Risk of Damage</p> <p>The mercury medium pressure lamps used in the system cannot be reignited while they are still hot.</p> <ul style="list-style-type: none"> • Please observe a cooling time of at least 10 minutes after switching the lamp off, before you can reignite it. An attempt to reignite a hot lamp can lead to damages of the system or parts of it.

 CAUTION	
	<p>Risk of Damage The system warms up during operation.</p> <ul style="list-style-type: none">• Make sure that there is an adequate air circulation at the installation site.• Air vents in the device housing must not be covered.

 CAUTION	
	<p>Risk of Damage The system must only be used when compressed air is present at the system.</p> <ul style="list-style-type: none">• Make sure compressed air is connected and available.• Air vents in the device housing must not be covered.

For activities in normal operation a brightness of at least 300 Lux must be provided.



Access to the machine is only permitted for operating personnel and instructed personnel.





Operation the machine is only permitted for instructed operating personnel.

Removing or disabling protective devices is not allowed during operation of the system.

If any protective devices or equipment fail or have become faulty, this must be reported to the operations supervisor immediately. He will decide about further procedure.

7.3 Radiation Safety

 WARNING	
	<p>Risk of eye injury UV-radiation is harmful! Always wear suitable safety glasses. Avoid direct exposition.</p> <p>This product is equipped with a UV lamp. There is a risk of photochemical or thermal damage of the eye, retinal damage of the eye and erythema. The operating staff is to be trained appropriately.</p> <p>For protection of the operating staff, do not look into the UV light and do not expose the skin continuously to UV radiation.</p> <p>Note: In case of a malfunction, the UV light can be switched on, even though the status LEDs or the trigger output does not signalize this. Before working with the device, please check that the lamp is switched off.</p>

 WARNING	
   	<p>Risk of injury due to UV irradiation</p> <p>When working with the BSM-03 always wear a face shield, safety goggles and gloves.</p> <p>The system is equipped with a UV lamp. There is a risk of photochemical damage to the eyes, retinal damages and erythema. The operating personnel must be trained accordingly.</p> <p>For the protection of the operating personnel: Never look directly at the UV lamp and do not expose your skin permanently to the UV radiation.</p> <p>Note: In case of a malfunction, the UV lamps can still be switched on, even if the BSM-03 does not indicate this. Prior to any works at the system, check that the UV lamps are switched off.</p>

7.4 Safety Information Concerning Service and Repair Work



	⚠ WARNING
	<p>Risk of injury! High Weight! Always carry the system with two persons.</p>



	⚠ WARNING
	<p>Risk of ozone intoxication! When using ozone-generating lamps, the exhaust air can be enriched with ozone. Ozone is harmful to health, if it is absorbed by the lungs over a prolonged period and in higher concentrations. Therefore, generally avoid inhaling ozone.</p> <ul style="list-style-type: none"> • Ensure an appropriate discharge and treatment of the exhaust air, so that the permissible ozone concentration at the workplace (MAK value) is not exceeded.

	⚠ WARNING
	<p>Risk of electric shocks! Before opening the system, disconnect all components from the supply voltage and check that no voltage is present.</p>

	⚠ CAUTION
	<p>Risk of Damage</p> <ul style="list-style-type: none"> • Switch off the control unit prior to connecting / disconnecting accessories. Due to the operating voltage of the unit, the accessories can get damaged. • Unplugging & plugging of signal cables during the operation is strictly forbidden!

	⚠ CAUTION
	<p>Risk of Damage</p> <ul style="list-style-type: none"> • Skin fat and dirt are absorbent in the UV and visible spectral range. The lamps can overheat locally. • Avoid fingerprints on the optically components, sensor surfaces, lamp, and reflectors. If necessary, the components must be cleaned carefully with Isopropyl.

 CAUTION	
	<p>Risk of Damage</p> <p>The system must only be used when compressed air is present at the system.</p> <ul style="list-style-type: none">• Make sure compressed air is connected and available.• Air vents in the device housing must not be covered.

 CAUTION	
	<p>Risk of Damage</p> <p>The system warms up during operation.</p> <ul style="list-style-type: none">• Make sure that there is an adequate air circulation at the installation site.• Air vents in the device housing must not be covered.

Service, repair and cleaning work must only be carried out by authorized and specifically trained professionals. The system must be power-free and secured before major work is carried out (including cleaning).

Carry out the prescribed setting, service and inspection work according to schedule. If you need further information or if special problems occur that are not treated extensively enough in this manual please request the required information from the manufacturer.

Only specialized electricians may perform work on electrical equipment.

Safety devices may only be removed during service and repairs, if the system was previously switched off and brought into a safe condition.

For service and maintenance work, important safety installations may not be functional. Work of this kind therefore requires special caution.

8 System Description

The BSM-03 UV curing chamber with an output of 2 kW is best suited for large-area UV curing, hardening, and bonding. The internal shutter is controlled by the UV-MAT for an accurate dose so that reproducible exposure is achieved even with medium-pressure lamps.

With irradiance of up to 150 mW/cm², the required dose is typically achieved within several seconds. The UV curing chamber can be opened for loading and unloading while the lamp is on. The shutter is monitored and closed with a safety circuit so that no UV radiation is emitted outside the chamber.

The sliding sample support also facilitates loading and unloading. It withstands all loads up to 20 kg. With 60 x 40 cm at the base and a height of 25 cm, the irradiation room offers plenty of space. The sample chamber temperature is about 45°C in operation. Due to the high uniformity of the irradiation, the samples may be positioned in any order.

For different applications, mercury, iron, and gallium lamps are available. Ozone generating lamps are available on request.

The components at a glance:

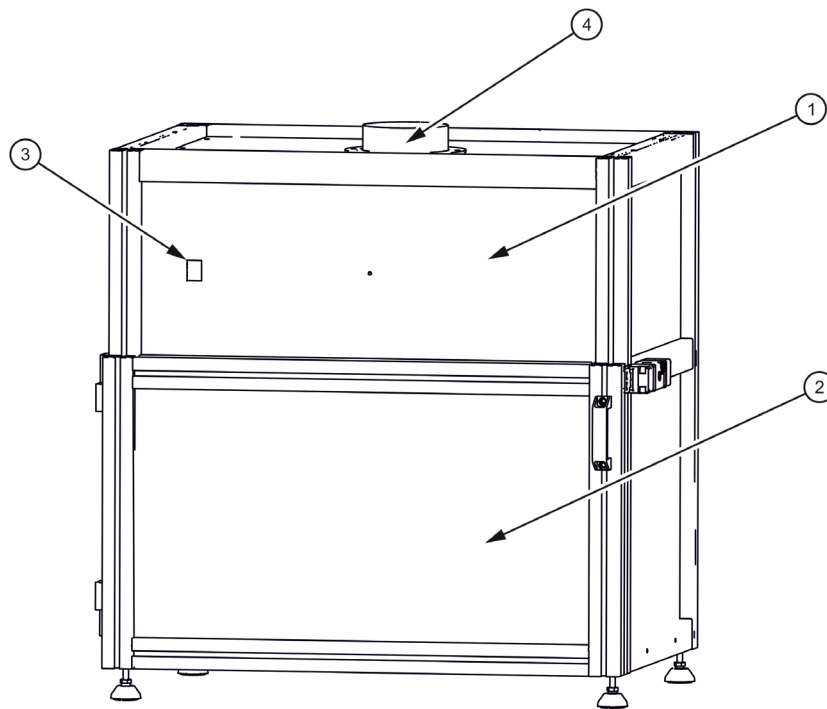

Pos.	Designation	Pos.	Designation
1	Irradiation chamber	2	Front door
3	Main switch	4	Air outlet for cooling

Inside chamber view, rear view and ventilation concept:

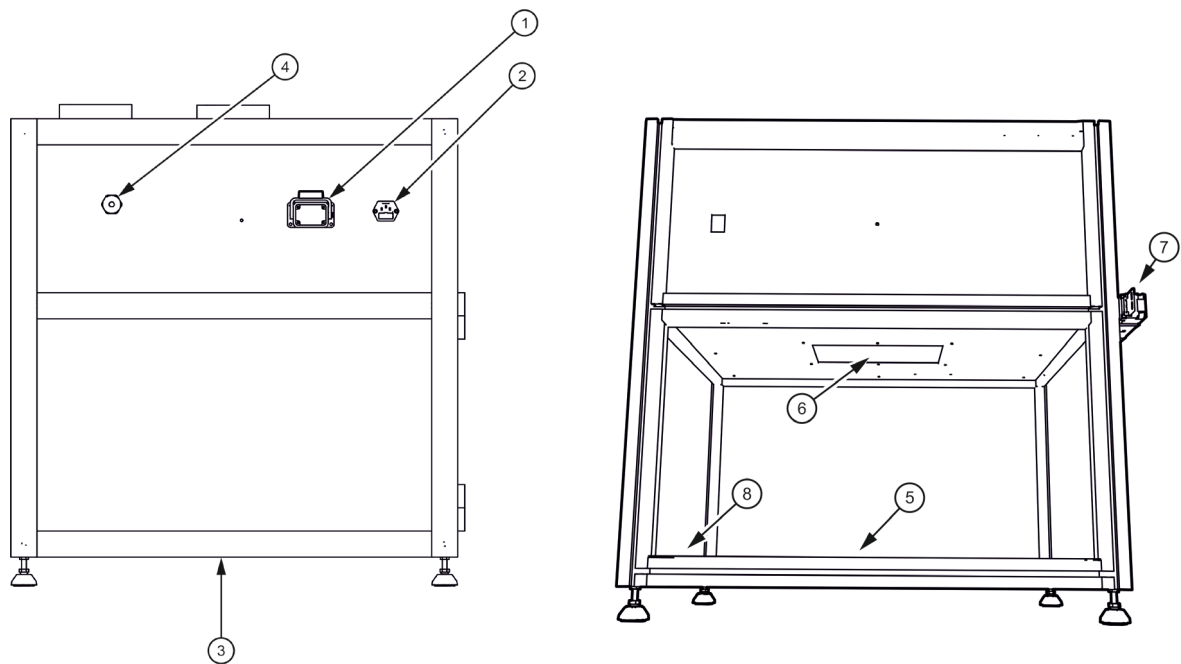

Pos.	Designation	Pos.	Designation
1	Harting connector for UV-MAT	2	Mains connector
3	Air inlet for cooling	4	Pressurized air inlet for shutter
5	Sample plane	6	UV lamp
7	Door security contact	8	Sensor holder

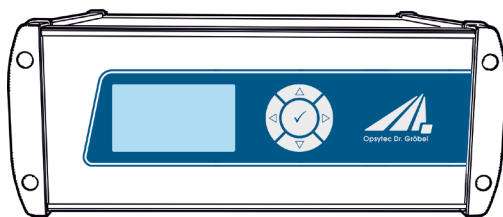

(1)

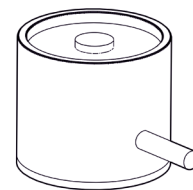

(2)

Pos.	Designation	Pos.	Designation
1	UV-MAT	2	Sensor

The UV-MAT unit contains the power supply, the microcontroller system with display and keyboard and the output controls. The sensor is connected to the backside of the LedControl unit.

The sensors are adapted to the lamps, meaning UV sensor for mercury lamps for example. The sensors are cosine corrected. Due to the excellent cosine correction it is possible to measure from a side position.

The following components are delivered:

- Irradiation chamber with pneumatic, rotating shutter and lamp ventilator
- UV lamp, preinstalled
- UV-MAT
- Power line cable
- This documentation



For a simple description, the above mentioned components are collectively referred to as system.

The following components are required by the customer:

- None, if ozone free lamps are used
- If ozone generating lamps are used ensure an appropriate discharge and treatment of the exhaust air, so that the permissible ozone concentration at the workplace (MAK value) is not exceeded.

9 Commissioning

- Unpack all components and remove the packaging materials.

	⚠ WARNING
	Risk of injury! High Weight! Always carry the system with two persons.

- The BSM-03 is delivered with a preassembled lamp. You don't need to install the lamp.
- Connect the compressed air for the shutter at the rear of the irradiation chamber.
- Connect the exhaust hose at the air outlet.
- The BSM-03 uses a ventilation system. Make sure that the air inlets are not covered.
- Connect the external UV MAT with the BSM-03.

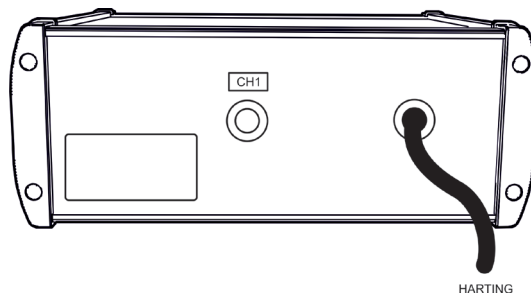

- Mount the sensor in the left-hand sensor holder inside the irradiation chamber.
- Remove sensor cap.
- Route the sensor cable through cable feedthrough in the rear side of the irradiation chamber.
- Connect the sensor with the UV-MAT.
- Connect the BSM-03 to the supply voltage.
- Switch on the system by means of the switch on the front side of BSM-03
- BSM-03 is completely operated by UV-MAT.

10 Operating

The irradiation chamber is switched on with the power switch on the front side.

In general:

- Switch on the irradiation chamber by means of the power switch. This immediately ignites the UV lamp. Wait 10 minutes until the lamp has reached the operating temperature.
- Open the front door of the irradiation chamber and place the objects to be irradiated in the irradiation chamber.
- Make sure that the built-in sensor is not covered for dose-controlled radiation.
- Close the front door of the irradiation chamber, otherwise the shutter won't open.
- Choose Operation mode: continuous irr. (irradiation), timer or dose*
- If necessary, check the irradiation intensity and use ∇ and \triangle keys to adjust the radiation intensity and check the sensor factor (see chapter 10.5)
- Start the irradiation by UV-MAT. At the end of the exposure open the front door of the irradiation chamber and carefully remove the irradiated objects.
- Switch off the lamp and let the system cool down. Then switch of the system.

10.1 Switching on the system:

Switch on the irradiation chamber by means of the power switch.



Close the door before switching on.

After switching the system on, a test is performed to see if the compressed air for the shutter is connected. If necessary, connect it.

Ignite the UV lamp at the UV-MAT and let the lamp burn for at least 2-10 mins. During that time the integrated shutter is open and the front door is locked.







If front door is not locked successful the lamp will be switched down.

10.2 Exposure:

Open the front door of the irradiation chamber and place the objects to be irradiated into the irradiation chamber.

For dose-controlled radiations please make sure that the integrated sensor is not covered.

Close the front door of the irradiation chamber otherwise the shutter will not open.

⚠ WARNING	
   	<p>Risk of injury due to UV irradiation</p> <p>When working with the BSM-03 always wear a face shield, safety goggles and gloves.</p> <p>The system is equipped with a UV lamp. There is a risk of photochemical damage to the eyes, retinal damages and erythema. The operating personnel must be trained accordingly.</p> <p>For the protection of the operating personnel: Never look directly at the UV lamp and do not expose your skin permanently to the UV radiation.</p> <p>Note: In case of a malfunction, the UV lamps can still be switched on, even if the BSM-03 does not indicate this. Prior to any works at the system, check that the UV lamps are switched off.</p>

⚠ CAUTION	
	<p>Risk of Damage</p> <p>The system must only be used when compressed air is present at the system.</p> <ul style="list-style-type: none"> • Make sure compressed air is connected and available. • Air vents in the device housing must not be covered.

Start the radiation at the UV-MAT. Controlling the radiation is done via the irradiation controller UV-MAT (see chapter 10.3).

After the radiation has been completed, the shutter is closed automatically and the front door is released. Open the front door of the irradiation chamber and take out the irradiated objects.

Close the front door of the irradiation chamber.

⚠ WARNING	
	<p>Risk of injury due to UV irradiation</p> <p>The front door is locked and monitored. If it is opened during the radiation, then the shutter is closed automatically. Since this is done mechanically, the user might be exposed to the UV radiation for a short time.</p> <ul style="list-style-type: none"> • The door must not be opened during irradiation

10.3 Switching off the system:

After usage, switch off the irradiation chamber firstly at the UV-MAT via the menu item "Shutdown". Hereby the lamp is cooled down precisely for 5 minutes. Afterwards switch off the BSM-03 via the power switch.

11 UV-MAT operation

The UV-MAT is operated via five keys. These keys are arranged in the front, right next to the display. The keys and the function configuration are shown below:

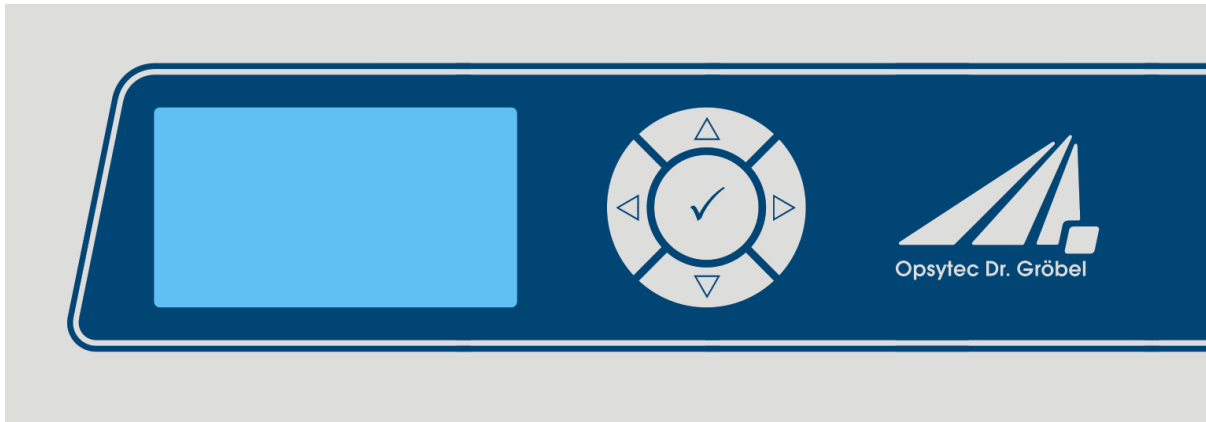

Key	Function
▽	Down
△	Up
◁	Left
▷	Right
✓	Confirm / OK

Initially after starting the device, the logo appears in the display for 2 seconds.



Now the device is in standby and is displayed in the main menu.

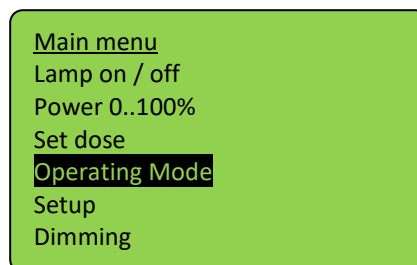

The menu items in the main menu depend upon the settings, i.e. the menu items "Performance 0..100%" and "Irradiation time" are only displayed, when the respective mode has been selected.

In the main menu and all other menus, select the active menu item via the keys ▽ and △. By clicking ✓ you confirm the selected menu item. With ◁ you return to the previous menu without adopting the changes.

The selected menu item is displayed on a black background and inverted.

LedControl offers two operation modes:

- Dose controlled
- Time controlled

11.1 Lamp on / off

First the lamp must be ignited. Start the ignition by selecting “Lamp On/Off” and press ✓.

A dialog window will appear and if the lamp should be ignited you have to confirm with ✓. Or you can press the button on the left to get back to the menu.

Lamp will be ignited. This may take up to 2 Minutes.

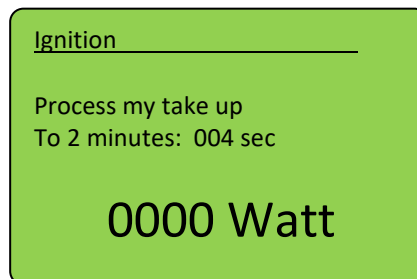

During this time, the ignition process can be interrupted at any time by long pressing ✓.

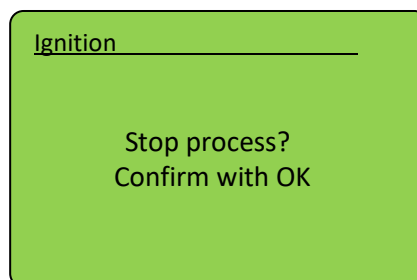

After the ignition process, a window will appear indicating that the lamp has been successfully ignited. Press OK to confirm the information and return to the menu.

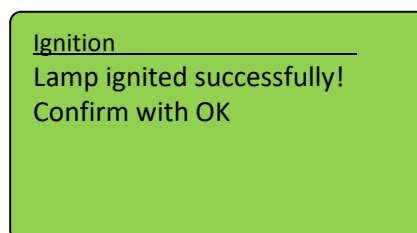

If the ignition is successful, the current lamp power is displayed.

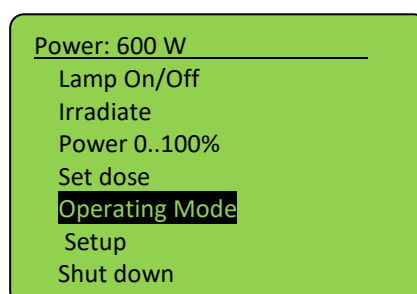

If the ignition is not successful, a window with the information indicating that the lamp has not been successfully ignited appears.

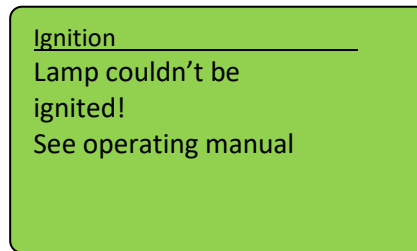

The lamp can be switched off by selecting the menu item " Lamp On / Off " again. Confirm with ✓.

The lamp is turned off and cooled for about 2 minutes. Afterwards, you are automatically taken to the main menu.

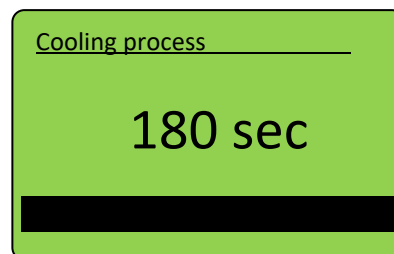

11.2 Power Modification

In the main menu select the menu item "Power 0..100%". In the submenu you can select the decimal with the keys ◀ or ▶ and set the power with the keys ▲ or ▼ to the desired value. Confirm with OK (✓) to return to the main menu.

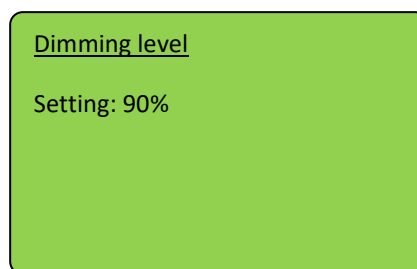

Dimming level can be changed during active irradiation with ▲ and ▼ keys.

11.3 Start / Stopp Radiation

Start an irradiation by selecting “Start Radiation” and press ✓.

In time controlled operation mode the remaining irradiation time, the lamp power and the dimming level are displayed.

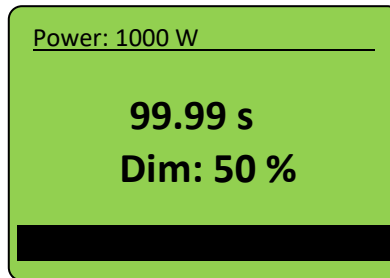

In dose controlled operation mode the current irradiance in mW/cm^2 , the actual irradiation time, the current dose (Is:) and the target dose (Set:) are displayed:

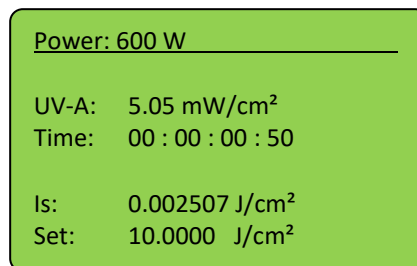

mW/cm^2 and J/cm^2 are automatically calculated.

Stop an irradiation by pressing ✓ for at least 2 seconds.

11.4 Operation mode

Select operating mode the select dose or time controlled irradiation.

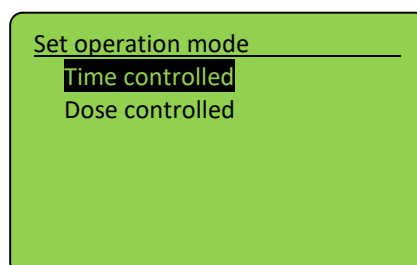

Confirm by with ✓ or ▷. With ◁ you can cancel your input and go back to main menu.

11.4.1 Timer mode

In the menu "Irradiation Time" you can set the irradiation time for the timer. Therefore select menu item "Set time". If "Set time" is not displayed, please choose "Timer" in menu "Operation Mode" first.

Now you can select the decimal with the keys ◀ or ▶ and with the keys △ or ▽ you can set the time to the desired value. Confirm with OK (✓) to return to the main menu.

In timer mode you can set the duration of irradiation:

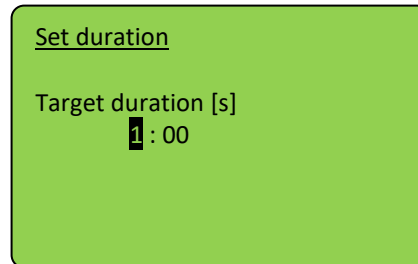

In timer mode, the LED is started for the pre-set exposure time and it switches off automatically afterwards. By clicking (✓), you can abort the exposure.

With the keys ▽ and △ the power can be modified during the exposure.



By clicking (✓) the exposure is aborted.

The maximum duration is 9999 s.

In time controlled mode the irradiation time controlled by a timer only. On the display only the irradiation time is displayed. A sensor is not necessary.

11.4.2 Dose controlled mode

Select operation mode dose.

Confirm by with ✓ or ▶. With ◀ you can cancel your input and go back to main menu.



In dose controlled mode the irradiation time is automatically controlled and stops if the desired dose is reached. Note a sensor must be connected therefore.

Set the target dose for an irradiation:

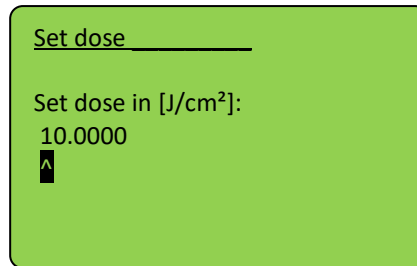

Use the ◀ key to add a digit.

Use ▲ and ▼ keys to change value and confirm with ✓.

Return to main menu and start an irradiation by selecting “Start Radiation”.

In dose controlled operation mode the current irradiance in mW/cm², the actual irradiation time, the current dose (Is:) and the target dose (Set:) are displayed:

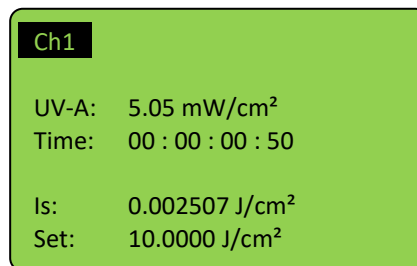

mW/cm² and J/cm² are automatically calculated.

Stop an irradiation by pressing ✓ for at least 2 seconds.

11.5 Setup menu

Using this menu you can set the system settings.

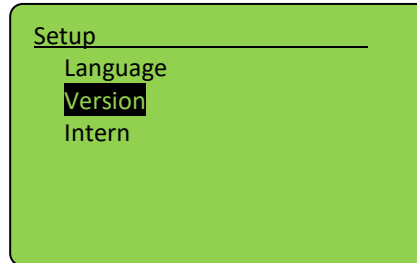

11.5.1 Language

The UVMAT comes with a menu in the German and English. Select the desired language with the keys ∇ and \triangle and confirm with \checkmark .

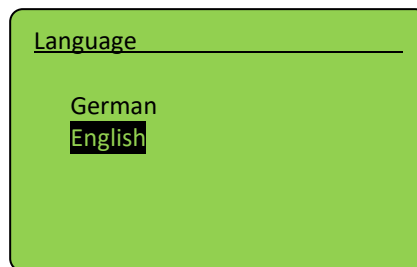

11.5.2 Version

This will show installed firmware version:

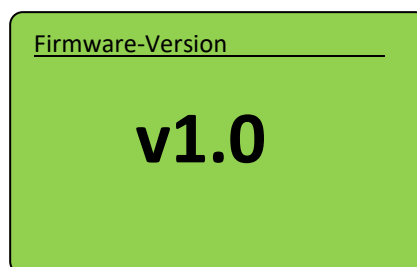

11.5.3 intern

To enter menu type in the PIN code, see *next chapter*.

11.6 Internal settings menu

Using this menu you can set the system settings. Therefore enter the PIN code, see *chapter technical data*, must be entered.

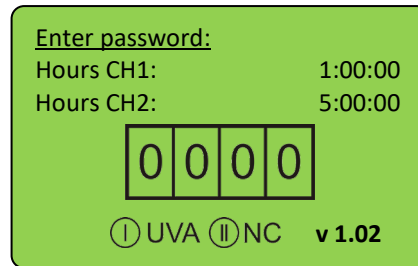

Even without PIN the operational hours, connected sensors and firmware version are displayed. After entering PIN and confirmation with OK you can change system settings:

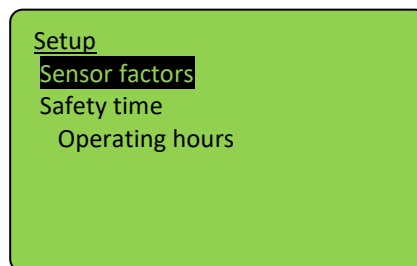

11.6.1 Sensor factors

In this submenu the sensor specific adjustments are placed. It is possible to do the sensor adjustment and set the upper and lower limits.

11.6.2 Calibration*

The sensor factor is used to calculate the irradiance for another place then the sensor place. For example:

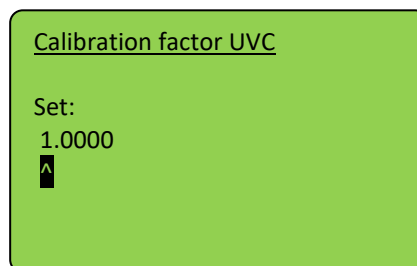

The standard value for this is 1.000 (one). Therefore the irradiance is the irradiance at the sensor place.

If you want to convert the reading for another position you have to measure the irradiance in the target position and in the sensor position. The result of the division from the target value and the sensor value is the necessary calibration factor.

Navigate with ◀, ▶ and set value with ▲, ▼. Confirm with ✓ to go back to setup menu.



Use the < key to add a digit.

11.6.3 Upper and lower limit / each spectral range

The upper and lower limits have the function of monitoring the sensors. For example:

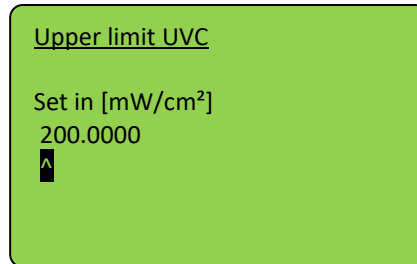

For the determination of the limit values you have to set the upper limit on 200 mW/cm² and the lower limit on 0 mW/cm². No error can occur with this setup (if the calibration factor is set to 1.0). After an adequate warm up time you have to read the values and can now adjust the upper and lower limit e.g. ±25% of the sensor value. Strong fluctuations during the warming up should be faded out with the delay time.

11.6.4 Safety time

Timing values can be adjusted in menu “safety time”. See delay time, max. time and waiting time.

Delay time

The delay time is the time, which the UV-Mat waits until it starts to monitor the sensor signal. It should be as long as the leds need to get on a constant irradiancy delivery.

Max. time

Max. time is a safety function. After reaching this time the irradiation is stopped.

Waiting time

The waiting time is the time after the irradiation which must be waited to start a new irradiation. This time should be so long, that double irradiation is to be excluded. It should be set at least to **3 seconds** to prevent immediate user restart.

12 Maintenance

12.1 Lamp Replacement for Version 2020 (from irradiation chamber)

The service life of UV medium pressure lamps depends on the plant dimensioning and the mode of operation (on/off switching cycles, cooling and contamination).

Frequent on/off switching of the BSM-03 will significantly reduce the lifespan.

The UV lamp must be replaced if it does not ignite or if the curing performance is not reached anymore.

	⚠ WARNING
	<p>Risk of electric shocks!</p> <ul style="list-style-type: none">• Prior to opening the system or performing works at the system, disconnect it from the power supply and check that no voltage is present.

For the lamp replacement, the BSM-03 is equipped with a removable UV aggregate. Please proceed as follows:

1. Disconnect the system from the power supply and check that no voltage is present.
2. Disconnect the compressed air supply.
3. Remove the upper cover (1) in the irradiation chamber. For this purpose, remove the screws.

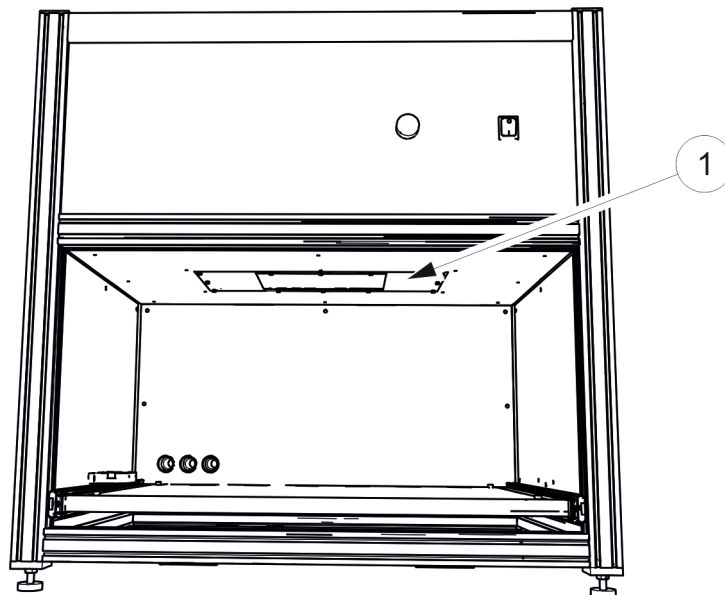

⚠ CAUTION	
	<p>Risk of Damage</p> <ul style="list-style-type: none">• Skin fat and dirt are absorbent in the UV and visible spectral range. The lamps can overheat locally.• Avoid fingerprints on the optically active sensor surface, lamp, and reflectors. If necessary, the components must be cleaned carefully with Isopropyl.• Use safety goggles and gloves when working inside sample room of the BSM-03 irradiation chamber.

4. Loosen the four screws of the ventilation metal sheet and remove them.

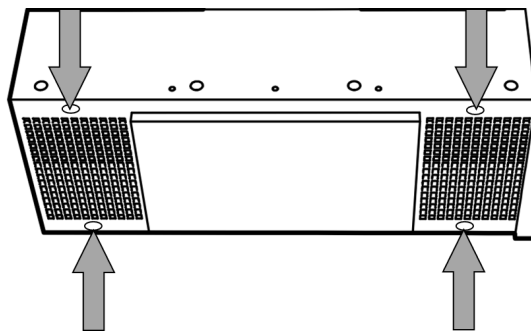

5. Remove the knurled nut on the left and the right of the electrical connections.
6. Now the lamp can be removed from the retaining clip at the base.



7. Loosen the knurled nuts of the securing bracket and tilt it.



8. Carefully remove the old lamp from the spring-steel clamp.
9. Now insert the new lamp.
10. Lock the securing bracket.
11. Connect the cable.
12. Reinsert the ventilation metal sheet and the upper cover (1) in the irradiation chamber and tighten it by means of the screws.
13. Switch on the compressed air supply again.
14. Reconnect the BSM-03 to the power supply.

	⚠ WARNING
	<p>Risk of sun burn! Risk of Cancer!</p> <p>The BSM-03 is equipped with a high-performance aggregate. To protect the operating personnel, the system must not be operated without the outer casing.</p>

12.2 Lamp Replacement until version 2020 (from the top)

The service life of UV medium pressure lamps depends on the plant dimensioning and the mode of operation (on/off switching cycles, cooling and contamination).

Frequent on/off switching of the BSM-03 will significantly reduce the lifespan.

The UV lamp must be replaced if it does not ignite or if the curing performance is not reached anymore.

	⚠ WARNING
	Risk of electric shocks! <ul style="list-style-type: none">• Prior to opening the system or performing works at the system, disconnect it from the power supply and check that no voltage is present.

For the lamp replacement, the BSM-03 is equipped with a removable UV aggregate. Please proceed as follows:

15. Disconnect the system from the power supply and check that no voltage is present.
- 16.
17. Disconnect the compressed air supply.
18. Remove the exhaust air hoses from the inlets
19. Remove the upper cover of the irradiation chamber. For this purpose remove the 12 screws in the cover.

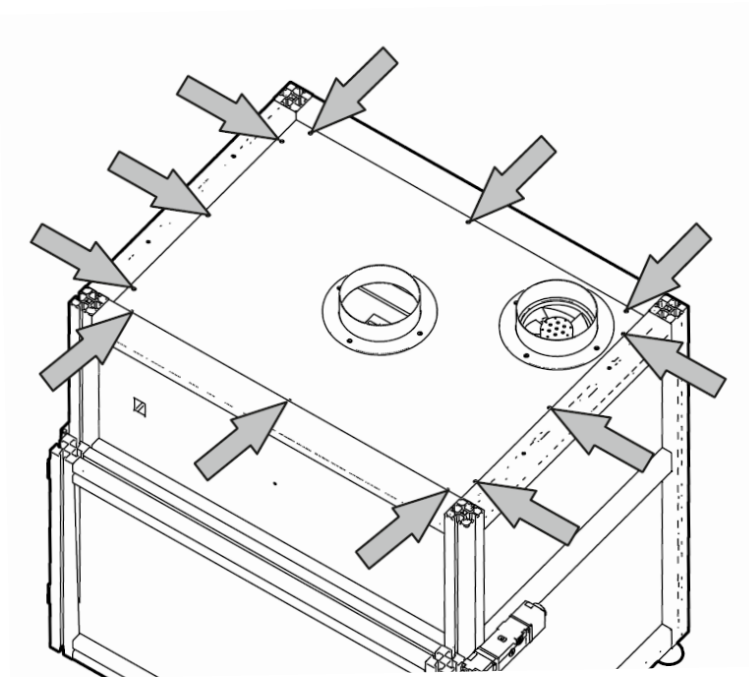

20. The cover can be placed down in front of the irradiation chamber with the PE line still connected. Please make sure that the cover with the hose inlets and the chamber ventilator is in a stable position.
21. Loosen the four lateral screws, which attach the lamp unit to the mounting plate.

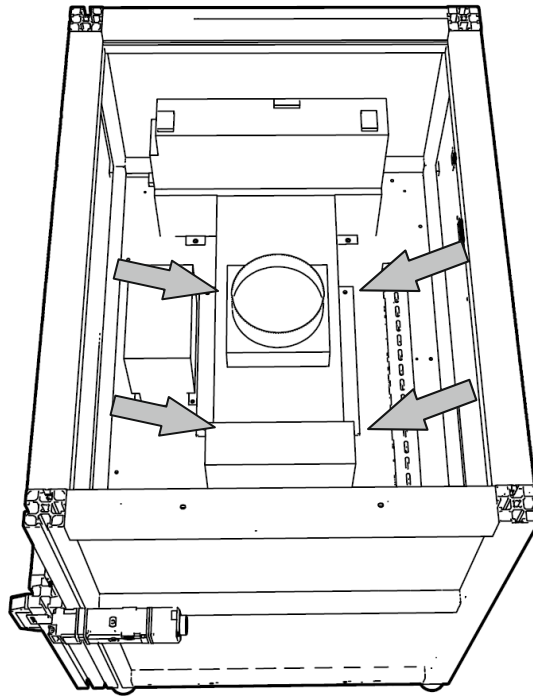

Attention: The screws marked in red must **not** be loosened.

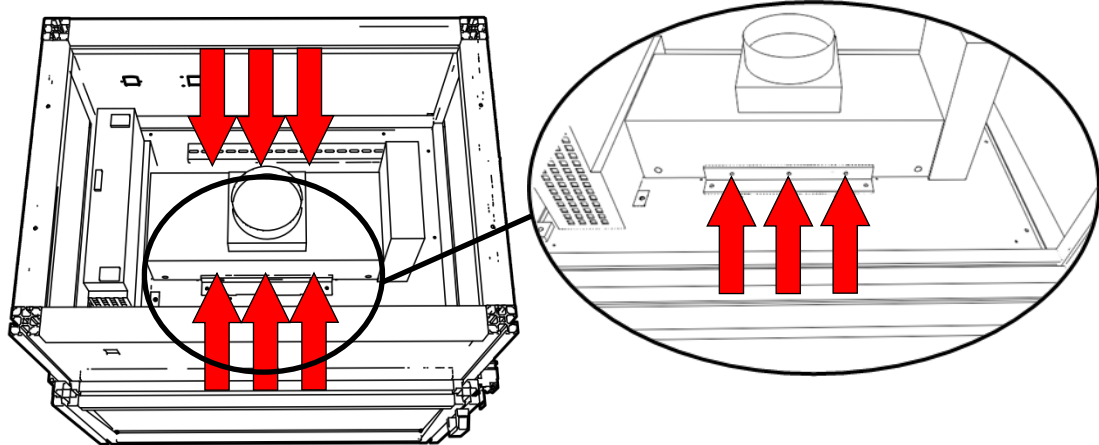

22. Remove the lamp unit in upward direction from the irradiation chamber. Rotate the lamp unit and place it (as shown below) on the frame.

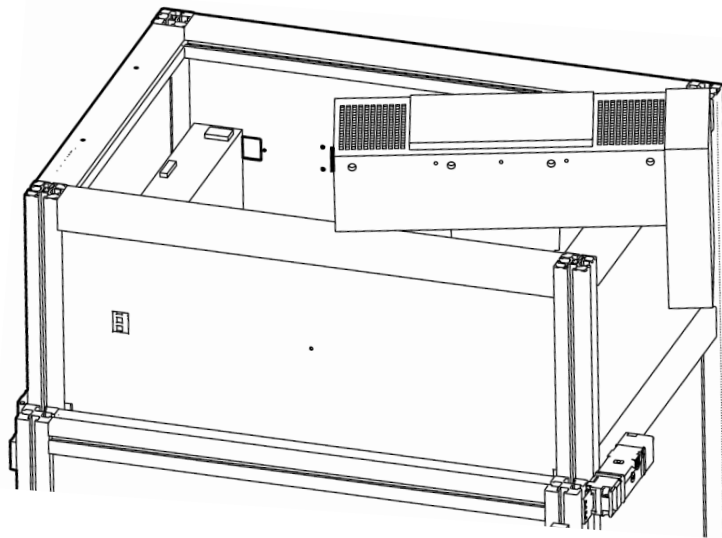

⚠ CAUTION	
	<p>Risk of Damage</p> <ul style="list-style-type: none">• Skin fat and dirt are absorbent in the UV and visible spectral range. The lamps can overheat locally.• Avoid fingerprints on the optically active sensor surface, lamp, and reflectors. If necessary, the components must be cleaned carefully with Isopropyl.• Use safety goggles and gloves when working inside sample room of the BSM-03 irradiation chamber.

23. Loosen the four screws of the ventilation metal sheet and remove them.

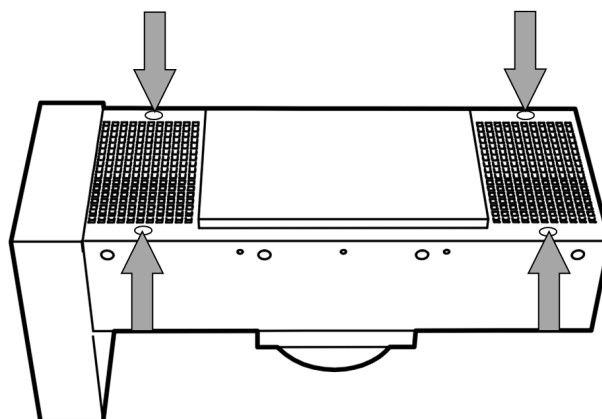

24. Remove the knurled nut on the left and the right of the electrical connections.

25. Now the lamp can be removed from the retaining clip at the base.



26. Loosen the knurled nuts of the securing bracket and tilt it.



27. Carefully remove the old lamp from the spring-steel clamp.

28. Now insert the new lamp.

29. Lock the securing bracket.

30. Connect the cable.

31. Reinsert the lamp unit in the irradiation chamber and tighten it by means of the four screws (Item 6). Please take care, that no cables or wires are pinched when inserting the lamp unit.

32. Put the upper cover back in place and switch on the compressed air supply again.
33. Reconnect the exhaust air hoses to the air inlets.
34. Reconnect the BSM-03 to the power supply.

	⚠ WARNING
	<p>Risk of sun burn! Risk of Cancer!</p> <p>The BSM-03 is equipped with a high-performance aggregate. To protect the operating personnel, the system must not be operated without the outer casing.</p>

13 Troubleshooting

The following notes and error messages address the user. The instructions shall help to ensure the proper operation. For this purpose, possible causes and remedies are indicated.

Error / Error message	Cause	Actions
Shutter does not open / close	Compressed air not connected	Check compressed air line
Lamp goes out in standby	Lamp temperature too low	Reduce the air volume by means of a butterfly valve
Lamp does not reach the maximum power	Lamp temperature too low	Reduce the air volume by means of a butterfly valve
Lamp ages prematurely	Lamp temperature too low	Check the lamp temperature Reduce the air volume by means of a butterfly valve
Lamp goes out during operation or continuous operation	Lamp temperature too high, excessive temperature switch trips	Check the air cooling. Are the air intakes (chamber floor) readily accessible? Is the exhaust air accessible? Is the suction active? Increase the air volume

14 Technical Data

General data	
Ambient temperature	+15 to +30 °C
Storage temperature	+5 to +60 °C
Humidity	< 80% non-condensing
Cooling	Exhaust air cooling, 1 x DN 100, up to 200 m ³ /h
Maximum housing temperature	< 60 °C
Dimensions, chamber	77cm x 62cm x 80cm
Weight, chamber	~80 kg
Type	tabletop device

Installation, minimum clearances	
Installation of the system	horizontal
Minimum clearance, above	4 cm
Minimum clearance, lateral	4 cm

⚠ DANGER	
	<p>Danger to life caused by high leakage currents for an interrupted protective conductor</p> <p>The inverter components conduct a high leakage current via the protective conductor. The earth leakage current of the SINAMICS V20 inverter may exceed 3.5 mA AC.</p> <p>Touching conductive parts when the protective conductor is interrupted can result in death or serious injury.</p> <p>A fixed earth connection or a multicore supply cable with connectors for industrial applications according to IEC 60309 is required and the minimum size of the protective earth conductor shall comply with the local safety regulations for high leakage current equipment.</p>

Mains connection and power	
Operating voltage and frequency	100 - 240 V, 50/60 Hz
Power factor	ca. 0.9 at max. radiation power
Safety device, on the mains side	Motor protection switch or machine with C characteristic, trip current ca. 33 A
Maximum input power	up to 2400 W
Connection UV-MAT	rear Harting plug
Used control gear	9931147
Manufacturer	Nedap

UV lamp	
Manufacturer	UV-Technik Meyer GmbH
Type	UVH 2022-0
Nominal performance	2.000 W
Standby performance	550-600 W
Illuminated length	206 mm
Pipe diameter	22.5 mm
Ozone-generating	yes
Main emission	UVC



Operating temperatures below 600°C affect the service life of the lamp.
Operating temperatures above 1070°C jeopardize the lamp.

Radiation distribution, typical

	1	2	3	4	5	6	7	8	9	10	11	12	13	14	15
1	44%	49%	55%	61%	65%	68%	71%	72%	70%	68%	65%	60%	54%	47%	43%
2	49%	55%	60%	70%	75%	79%	83%	85%	83%	81%	76%	69%	61%	55%	50%
3	53%	62%	70%	79%	86%	91%	96%	98%	96%	91%	86%	78%	68%	60%	53%
4	49%	61%	70%	79%	87%	92%	97%	98%	96%	92%	86%	79%	69%	59%	52%
5	49%	55%	68%	80%	88%	94%	99%	100%	98%	93%	87%	79%	68%	59%	51%
6	45%	55%	66%	76%	84%	90%	94%	96%	94%	89%	83%	75%	65%	56%	48%
7	46%	57%	67%	77%	84%	90%	94%	96%	94%	89%	84%	76%	65%	56%	49%
8	49%	54%	62%	71%	78%	82%	86%	87%	85%	81%	76%	69%	60%	52%	47%
9	43%	48%	53%	60%	65%	69%	71%	71%	70%	75%	64%	59%	53%	46%	42%
10	39%	43%	48%	53%	57%	60%	62%	62%	61%	60%	55%	52%	47%	41%	38%

Relative radiation distribution on the irradiated area

Radiation distribution overlapping the irradiated area

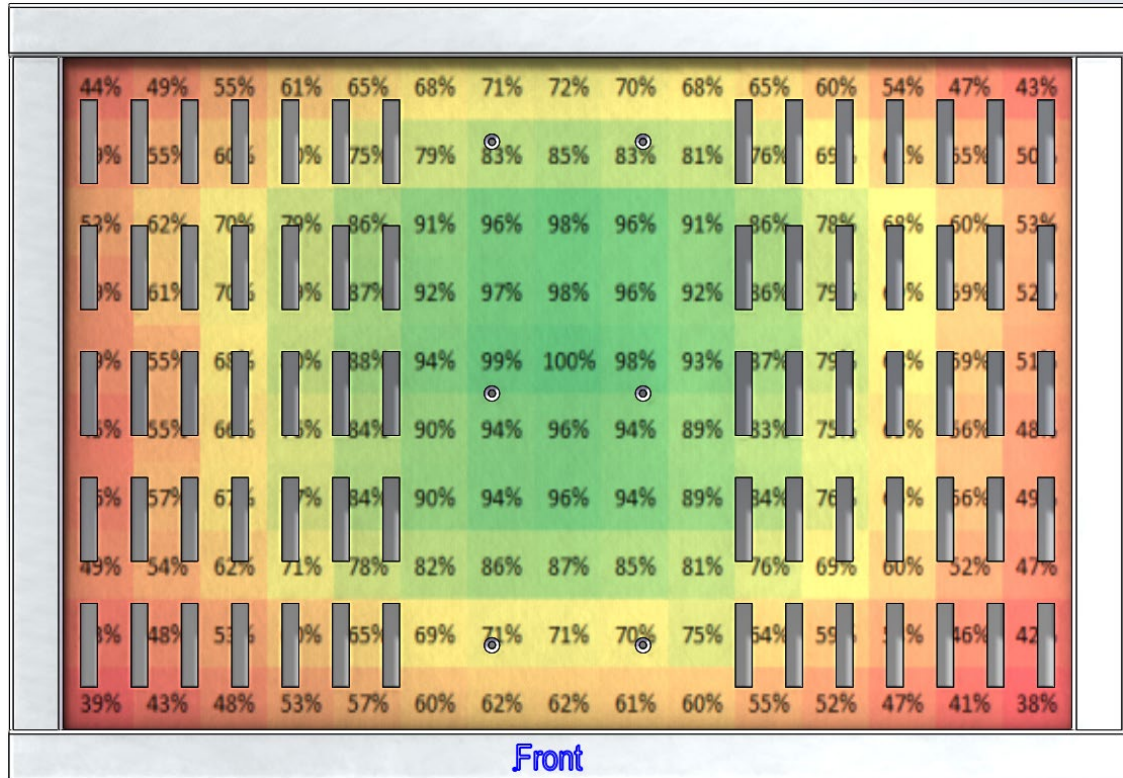

Control	
On/Off switch	On/Off switch on the front panel
Control	Via external control unit UV-Mat

Gases	
Compressed air	4 to 6 bar
Connection	4 mm

UV-MAT	
Size (L x W x H)	250 x 185 x 100 mm ³
Weight	2,6 kg
Power	Via BSM-03
Operational temperature	0 - 30°C
Storage temperature	0 - 60°C
Humidity	< 80%, non-condensing
Display	graphical, 128 x 64 px
Dose calculation	for all irradiance readings > 0,1 mW/cm ² to avoid offset failure
Size (L x W x H)	250 x 185 x 100 mm ³

Sensor	
Weight	150g
Operational temperature	0 - 40 °C
Storage temperature	-10 - 40 °C
Humidity	< 80%, non-condensing
Spectral range, UVC	200 – 280 nm
radiometric measurement range	0 – 19,9 mW/cm ²
Cosine correction	yes
Calibration	yes, traceable to PTB / NIST
frequency of checks (Recalibration)	12 months

PIN	
CODE NUMBER	7243

15 Spare Parts



When ordering spare parts, please contact:

Opsytec Dr. Gröbel GmbH

Am Hardtwald 6-8

76275 Ettlingen

Germany

Phone +49 - 7243 - 94 783 - 50

Fax +49 - 7243 - 94 783 – 65

Visit our website at: www.opsytec.de

16 Declaration of Conformity

Hereby we,

**Opsytec Dr. Gröbel GmbH
Am Hardtwald 6-8
76275 Ettlingen**

declare that the following product

Irradiation Chamber BSM-03

Type designation:

Irradiation Chamber 860813 with UV-MAT and sensor

have been developed, constructed and produced under our sole responsibility and that the product is conform with the following standard(s) or guideline(s) in this declaration:

2014/35/EU

“Directive of the European Parliament and of the Council on the harmonization of the laws of the Member States regarding the provision of electrical equipment for use within certain voltage limits on the market (Low-Voltage Directive)“.

2006/42/EG

“Directive of the European Parliament and of the Council on machinery and amending Directive 95/16/EG (Machinery Directive)“.

Ettlingen, 19.10.2015

Dr. Mark Paravia
Executive Board