

UV LED LedControl Serie L

manual



Version 3.0.2

Opsytec Dr. Gröbel GmbH
Am Hardtwald 6-8
D-76275 Ettlingen
info@opsytec.de
www.opsytec.de
Telefon: +49(0)7243 / 9 47 83-50

Table of contents

1	Foreword	4
2	Guidelines and standards	5
3	Identification	6
3.1	Manufacturer, ordering spare parts and after-sales service.....	6
3.2	Change history.....	6
3.3	Copyright	6
3.4	Device identifier	7
3.5	Intended use	7
4	General	8
4.1	Information about this Manual	8
4.2	Information about the Symbols	10
4.3	Owner/Operator Information	13
4.5	Personal Protective Equipment	16
5	Safety instructions and residual risk	17
5.1	General	17
5.2	Safety instructions relating to normal operation	18
5.3	Radiation safety	19
5.4	Safety instructions relating to service and repair work	21
6	Description of the system and function overview	23
6.1	LedControl for Spot P, Series L and SFL	23
7	LED Module L Series	25
8	Commissioning	26
8.1	Connection example of the LEDCONTROL DC	28
8.2	Connection example for PL KAT 4	28
9	Operation	29
9.1	Switch on	30
9.2	Switch off	30
9.3	LED On / Off	31
9.4	Change the power	32
9.5	Timer mode / irradiation time	33
9.6	Settings in the main menu	34
9.7	Settings in the settings menu	34
9.8	Leveling - Level multiple LED segments*.....	38
10	Remote operation - programming interface *	39
10.1	Definitions	39
10.2	Type definition	40
10.3	Command structure specifications	40
10.4	Error handling / timeout	40
10.5	Command overview	41
10.6	Checksum	43
10.7	Initialization	44

10.8	Example program for starting the LEDControl	45
10.9	Example program sections for different functions of the trigger	45
11	Fehler / Error.....	46
12	Software - LedControl Remote for programming interface*	47
12.1	Install software	49
12.2	Working with the software.....	49
12.3	Activate LED channels.....	50
12.4	Switching LED channels on and off.....	51
12.5	Change intensity	51
12.6	Program timer	52
12.7	Use and manage presets.....	53
12.8	Trigger modes.....	54
13	Technical data	55
13.1	Interface assignment	56
13.2	Control 57	
13.3	LED modules	57
13.4	Cooling of the LEDs.....	58
14	Spare parts	59
15	Transport, storage and disposal	60
16	Fehler / Störungen	Fehler! Textmarke nicht definiert.
17	Wartung.....	Fehler! Textmarke nicht definiert.
18	Declaration of Conformity.....	63
19	NOTES.....	64

1 Foreword

Dear customer!

Thank you for choosing a product made by us!

Please take some time to read this manual carefully. Please pay special attention to the safety instructions.

This is the condition for safe handling and operation of the system and its components.

If you have any questions that are not answered in this manual, please feel free to call us. We will be glad to help you.

Our products are subject to constant further development; therefore, there may be minor deviations between your system and the illustrations in this operating manual.

We will be happy to help you with any questions or problems. You can reach us at the address below. We are also always happy to receive suggestions or ideas for improvement.



Please note that the manufacturer of this device accepts no liability for the quality of the irradiation result of the irradiated material, as this depends on many factors. Always check the irradiation result after irradiation and adjust the irradiation if necessary.

**THIS MANUAL CONTAINS IMPORTANT SAFETY INSTRUCTIONS.
KEEP THESE INSTRUCTIONS.**

© 2023

Opsytec Dr. Gröbel GmbH

Am Hardtwald 6-8

D - 76275 Ettlingen

All rights reserved. Reprinting, including excerpts, is only permitted with the written consent of Opsytec Dr. Gröbel GmbH.

2 Guidelines and standards



The system is machinery under Annex II A of the Machinery Directive and is therefore delivered with a declaration of conformity and with a CE mark (in accordance with the Machinery Directive).

Directives	
EC Directives	06/42/EC (Machinery) (partially observed) 2014/30/EC (EMC) 2014/35/EC (Low voltage)
Harmonized standards	
EN ISO 12100:2010	Safety of Machinery – General Principles for Design Risk Assessment and Risk Reduction
EN 61000-6-2:2005	Electromagnetic Compatibility (EMC) – Part 6-2: Immunity for Industrial Environments
EN 61000-6-4:2007 + A1:2011	Electromagnetic Compatibility (EMC) – Part 6-4: Emission Standard for Industrial Environments

3 Identification

3.1 Manufacturer, ordering spare parts and after-sales service

Opsytec Dr. Gröbel GmbH
 Am Hardtwald 6-8
 D - 76275 Ettlingen
 Tel.: +49(0)7243 / 9 47 83-50
 info@opsytec.de
 www.opsytec.de

3.2 Change history



We reserve the right to make changes to the content. Opsytec Dr. Gröbel GmbH is not liable for any errors in this documentation. No liability is accepted for indirect damage arising from the supply or use of this documentation, to the extent permitted by law.

Version	Processor	Date	Change
3.0.0	Small	11.01.2022	Summary LedControl / LED Modules, Leveling
3.0.1	Paravia	01.03.2023	Red. Changes
3.0.2	Paravia	07.12.2023	Red. Changes

3.3 Copyright



Opsytec Dr. Gröbel GmbH shall retain the copyright for this operating manual. The operating manual is intended for the owner/operator and his personnel.

Copyright in accordance with DIN ISO 16016:

Reproduction and copying of this document, use and disclosure of the contents in this document are strictly prohibited unless expressly authorized.

Non-compliance may lead to a claim for damages. All rights in the case of a patent application, utility model or design are reserved.

Violations may be subject to criminal prosecution.

3.4 Device identifier

Data for internal use:

Description of the machine:	LedControl UV LED System
Year of manufacture:
Machine no.
Project no.

3.5 Intended use

The LED system is a high-intensity light source for curing UV adhesives and potting compounds or similar products. With the associated radiometer, precise control of the irradiance can be achieved.

The system is intended for industrial use in ordinary locations only as defined by the National Electric Code (NEC), NFPA 70. It is prohibited to use the equipment in hazardous areas or for general lighting.

It is prohibited to use the devices in potentially explosive atmospheres or for general lighting purposes

- Installation, commissioning, operation, maintenance and service work may only be carried out by trained and qualified personnel who comply with all safety guidelines and standards.
- Responsibility: Damage resulting from unintentional or unauthorized tampering terminates any right to assert warranty or liability claims against the manufacturer.
- Warranty Disclaimer: The use of any non-original parts will void the warranty.
- Environmental protection: Defective parts containing substances harmful to the environment must be disposed of accordingly.
- During operation, a high-energy, UV and / or visible radiation is generated.
- Operation is only permitted in a dry environment. The installation is horizontal.
- Only suitable for indoor operation.
- An extremely high irradiance is achieved at the output of the LED modules, which can ignite flammable materials in cases of continuous irradiation. Remove all combustible materials and observe the irradiation time and material temperature.
- Before opening, the system must be disconnected from the voltage and it must be checked that there is no voltage.
- Wear gloves for maintenance and cleaning.
- Do not clean the system when it is in operation.
- Any use other than that mentioned above will result in damage to the product. Furthermore, this is related to dangers such as short circuits, fire and electric shock. The entire device must not be changed and/or modified! The safety instructions must be observed at all times.

The warranty conditions are subject to the Civil Code (BGB) of the Federal Republic of Germany. The warranty period is 1 year, unless otherwise agreed in the purchase documents.

4 General

IMPORTANT SAFETY PRECAUTIONS

WARNING - Always observe the following basic precautions when using electrical equipment:

- a) Read all instructions before using the equipment.
- b) This equipment is to be used only by qualified and trained personnel.
Refer to the training section in this manual.
- c) Know how to turn off the product. Become thoroughly familiar with the
familiarize yourself with the controls.
- d) Stay alert - watch what you are doing.
- e) Do not operate the product when you are tired or under the influence of
alcohol or drugs.
- f) Keep danger area away from all persons.
- g) Do not place the product on an unstable surface.
- h) Follow the maintenance instructions given in the operating manual.
- i) Keep these instructions in a safe place.

4.1 Information about this Manual

This manual intends to make handling of this system and its components safe and efficient. The manual is part of the system and must be kept in its immediate vicinity where it is accessible for the personnel at any time.

This documentation contains the necessary information for the intended use of the described system. It is intended for technically qualified personnel who have been especially trained for operation, laboratory use, quality assurance, service and repair.

The personnel must have read this manual carefully and understood its content before commencing any work. The basic condition for safe working is observation of all stated safety information and operating instructions in this manual.

Knowledge and technically faultless implementation of the instructions, safety requirements, safety information and warnings are a condition for safety in operation, service and repair. Only qualified personnel has the required professional knowledge to apply the safety requirements, safety information and warnings stated in this operating manual in a general way correctly in a concrete situation.

In addition, the local accident prevention regulations and general safety regulations apply for the area of application of the system.

Illustrations in this manual serve the purpose of general understanding; they may differ from the actual version.

Apart from this manual the instructions for the installed components included in the appendix apply.

This operating manual cannot take any possible case of maintenance into account. If you need further information or if special problems occur that are not treated extensively enough in this manual please request the required information from the manufacturer.



For a simple description, the above mentioned components are collectively referred to as system.

4.2 Information about the Symbols

4.2.1 Safety Instructions

In this manual, safety information is indicated by means of symbols. Safety information is preceded by signal words that indicate the scope of risk.

To avoid accidents and damage to persons or property, always follow the information and act prudently.

Throughout the text, you will find the following pictograms with the following meanings:

	⚠ DANGER
	<p>Imminent danger Possible consequences: death or most serious injuries.</p> <ul style="list-style-type: none"> • Prevention

	⚠ WARNING
	<p>Dangerous Situation Possible consequences: death or most serious injuries.</p> <ul style="list-style-type: none"> • Prevention

	⚠ CAUTION
	<p>Possible Situation Possible consequences: slight or minor injuries. Sometimes also used for warning of material damage.</p> <ul style="list-style-type: none"> • Prevention



Note

Information for use or useful important information

4.2.2 Prohibition Signs



General "Prohibited-sign"

4.2.3 Warning Signs



Warning of optical radiation
(such as UV, IR, or visible radiation)



Warning of hot surface!



Warning of electricity!

4.2.4 Attention



Wear eye protection!



Opaque eye protection must be worn!



Disconnect mains plug from electrical outlet!



Disconnect before carrying out maintenance or repair!



Use hand protection!



Wear foot protection!



Refer to instruction manual/booklet

4.2.5 Optional functions

- * Optional functions, not available for every system

4.3 Owner/Operator Information

The System is used in the commercial sector. The owner/operator of the system is therefore subject to the legal obligations concerning work safety.

In addition to the safety information in this manual, the generally applicable regulations valid for the application area of the system concerning safety, prevention of accidents and for protection of the environment must be noted and complied with.

The following applies in particular:

The owner/operator must acquire information about the valid occupational health and safety information and in a risk assessment determine additional hazards incurred due to the special operating conditions at the location of use of the system. He must implement these in the form of operating instructions for operation of the system and specifically for the individual work stations.

The owner/operator is obliged to check during the entire lifetime of the system whether the operating instructions that he generated comply with the current status of the regulations and update them if necessary.

The owner/operator must assign and define the responsibilities for installation, operation, rectification of faults, service and cleaning unambiguously.

The owner/operator must ensure that all personnel dealing with the system have read and understood this manual. Furthermore, he is obliged to provide personnel training in regular intervals and provide information about risks.

The owner/operator must provide the required personal protective equipment for his personnel. Furthermore, the owner/operator is responsible that the system is always in faultless technical condition. To ensure this, the service intervals specified in this manual and in the technical documents for the individual systems must be observed and all safety installations must be checked regularly for function and completeness.

The owner/operator must have all safety devices checked regularly for function and completeness.

The owner/operator must ensure that the operating personnel have knowledge about first aid measures and local rescue installations.

6.4 Personnel Requirements

The maximum number of qualified professionals allowed to be at the site at the same time: 2

4.4.1 Qualifications

⚠ WARNING	
	<p>Risk of injury when personnel are insufficiently qualified!</p> <p>If unqualified personnel carries out work on the system or stays in the danger area of the system risks arise that may cause severe injuries and serious material damage.</p> <ul style="list-style-type: none"> • Have all activities carried out only by personnel qualified for the activity. • Keep unqualified personnel away from the danger area.

⚠ WARNING	
	<p>Risk of injury when touching live parts or hot surfaces</p> <p>Generally, low voltage devices like this system can have dangerous live parts and hot surfaces. All works for transportation, installation, commissioning, start-up and maintenance must be performed by respectively trained and responsible, qualified personnel (in accordance with EN 50110-1 (VDE 0105-100); IEC 60364). Inappropriate behavior can lead to serious injuries or damages.</p> <p>During the irradiation the LAMP temperature may rise up to approx. 60° C. Caution - risk of burns.</p>

Below, this manual lists the qualifications of the personnel for the various areas of activity:

4.4.2 Electrically skilled person

Due to their professional training, knowledge and experience and knowledge of the relevant standards and regulations, electrically skilled persons are able to carry out work on electrical systems and to recognize and avoid risks independently.

Electrically skilled persons are specially trained for the work environment where they are working and they know the relevant standards and regulations. Electrically skilled persons must fulfil the requirements of the valid legal regulations for accident prevention.

4.4.3 Qualified person

Qualified persons are trained or can be trained by Opsytec Dr. Gröbel GmbH in extended operation and parameterization of the system as well as in execution of preventive service work.

In addition, due to their technical training, knowledge and experience and knowledge of the relevant standards and regulations, they are able to carry out work they have been assigned and to recognize and avoid possible risks independently.

4.4.4 Operators

Operators use and operate the system in the scope of the intended use. They are trained by the owner/operator in the work assigned to them and informed about possible risks.

4.4.5 Training and Qualification of Personnel

In regular instructions and training, operating personnel must be informed about the special risks when working with and handling the system.

The instruction and training should have the following content:

- Hazards when working with the system in normal operation.

- Hazards in connection with service, repair and cleaning activities.

- Conduct to minimize consequences of accidents.

- Conduct in case of accidents.

- Rescue of injured persons.

- Working without personal protective equipment may cause health damage. The company supervisor is instructed to pay attention that personnel are wearing personal protective equipment.

- Particular hazards when working on the electrical system.

Instruction and training must be carried out in regular intervals by the owner/operator. For better tracking, execution of instruction and training should be recorded.

4.5 Personal Protective Equipment

The purpose of personal protective equipment is to protect the personnel from risks that might affect his safety or health when working.

When executing various activities on and with the system, the personnel must wear personal protective equipment. This will be pointed out again in the individual chapters of this manual. Below, personal protective equipment is explained:

4.5.1 Protective Gloves

Protective gloves are used to protect hands from visible and invisible radiation, friction, abrasion, stabs and deep injuries.

4.5.2 Protective Goggles

Protective goggles are used to protect eyes from intense visible and invisible radiation. Safety glasses and storage boxes can be ordered from Opsytec Dr. Gröbel GmbH, Am Hardtwald 6-8, 76275 Ettlingen or UVEX AREITSSSCHUTZ GMBH, Würzburger Str. 181 - 189, 90766 Fürth, Germany:

Protective eyewear part number: 9169065

Storage box part number: 9957502

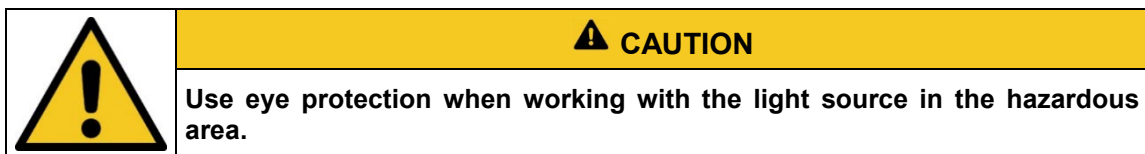

4.5.3 Safety Boots



Safety boots are used as protection from heavy parts falling down and slipping on slippery surfaces.

5 Safety instructions and residual risk



5.1 General



The system is state of the art and has been built in accordance with recognized safety regulations. Nevertheless, its use may pose risks to the life and extremities of the operating and repair personnel (service personnel) or third parties, or impair the machine. Operate the system only if its safety devices are in perfect condition. Malfunctions that impair their safety must be rectified immediately.

The following safety information must be strictly observed to avoid damage to the machine and personal injury!

	<p style="text-align: center;">⚠ WARNING</p> <p>Risk of injury if personnel do not read the operating manual! Before commissioning and operation, read the operating manual completely. Read all safety notes and instructions. Carelessness with regard to the safety notes and instructions can lead to electric shock and/or serious injury.</p>
	<p style="text-align: center;">⚠ WARNING</p> <p>The contact Enable/ENABLE is not a safety circuit. The enable/ENABLE contact is an enable contact and does not replace a safety circuit.</p>
	<p style="text-align: center;">⚠ WARNING</p> <p>NOTES ON VISIBILITY Use a hardware signal output and a PLC visualization, a signal lamp or the device display, if applicable, to indicate that the radiation source is "on".</p>

5.2 Safety instructions relating to normal operation

	 DANGER
	<p>Danger to life</p> <p>Danger to life occurs if the system is operated with defective or missing safety devices.</p> <ul style="list-style-type: none"> The system should only be operated when all safety devices and safety-related installations are present and in working condition. The operator of the machine is obliged to check the safety devices regularly, before production is started, for proper functioning.

	 WARNING
	<p>Fire hazard!</p> <p>An extremely high irradiance, which can ignite combustible materials in case of permanent irradiation, is reached at the output of the LED modules. Remove all combustible materials and observe the irradiation time and material temperature.</p>

During activities in normal operation, a brightness of at least 300 lux must be provided.

Access to the machine is only allowed to the operating personnel and instructed personnel.

The machine may only be operated by instructed operating personnel.

Use extreme caution around the high power light source. Never look directly into the leds or led modules.

The wearing of personal protective equipment (e.g. safety goggles and hand protection) is mandatory when working on the system.



Removal or deactivation of protective devices is not permitted during operation of the system.



If a protective device or equipment fails or becomes defective, this must be reported immediately to the plant supervisor. The latter will then decide on the further procedure.



Please note that the manufacturer of this device accepts no liability for the quality of the irradiation result of the irradiated material, as this depends on many factors. Always check the irradiation result after irradiation and adjust the irradiation if necessary.

5.3 Radiation safety

 DANGER	
	<p>RISK OF INJURY TO PERSONS</p> <ul style="list-style-type: none">• Ultraviolet radiation emitted by this product. Avoid exposure. <p>ALWAYS WEAR PROTECTIVE CLOTHING. EXPOSURE CAN LEAD TO CANCER AND PREMATURE SKIN AGING. ALWAYS WEAR SAFETY GLASSES. FAILURE TO DO SO MAY RESULT IN SEVERE BURNS OR LONG-TERM INJURY TO THE EYE AND SKIN.</p> <p>Never look directly into the lamp. As with natural sunlight, exposure can cause eye and skin allergies and allergic reactions. Medications or cosmetics may increase your sensitivity to ultraviolet radiation. Consult a physician before using this product if you are taking medication, have skin problems, or feel particularly sensitive to sunlight.</p>

 WARNING	
	<p>Risk of eye injury</p> <p>The LED system is equipped with high-power LEDs. There is a risk of photochemical or thermal damage to the eye, retinal damage and burns. Visible (blue) light can cause photochemical damage to the eye. If necessary, use suitable protective goggles when operating the unit. The operating personnel must be trained appropriately.</p> <p>Recommended protective equipment:</p> <ul style="list-style-type: none">- Gloves- colored safety glasses, no transmission below 500 nm <p>Do not look into the LED and do not expose skin to radiation! Avoid reflections of the radiation into the eye! The installation should be designed to prevent a direct view into the LED and the LED modules.</p>

	⚠ WARNING	
	The devices were classified in risk group 3 according to DIN EN 62471:2009-03 "Photobiological safety of lamps and lamp systems".	
	DIN EN 62471:2009-03 Risk group 3: Luminaires pose a hazard even for transient or brief irradiation. Use in general lighting is not permitted.	Caution dangerous ultraviolet radiation

The risk assessment for the workplace is the responsibility of the customer. This requires measurements / assessments according to DIN EN 14255-1:2005-06 "Measurement and assessment of personal exposure to incoherent optical radiation - Part 1: Ultraviolet radiation emitted by artificial sources at the workplace".

DIN 14255-1 itself does not contain any limit values. These are given in Directive "2006/25/EC of the European Parliament and of the Council on the minimum health and safety requirements regarding the exposure of workers to the risks arising from physical agents (artificial optical radiation)".



5.4 Safety instructions relating to service and repair work



	⚠ WARNING
	<p>Risk of injury! High weight! Always carry the LED system with two people.</p>

	⚠ WARNING
	<p>Risk of injury when touching live parts Before opening the LED module or the LedControl, disconnect all components from the supply voltage and check that no voltage is present.</p>

	⚠ CAUTION
	<p>Risk of damage</p> <ul style="list-style-type: none"> • Switch off the control unit before connecting / disconnecting an LED module. LED modules can be damaged due to the operating voltage. • Unplugging & plugging signal cables and LED modules during operation is strictly prohibited!

	⚠ CAUTION
	<p>Risk of damage</p> <ul style="list-style-type: none"> • Skin grease and dirt are absorbent in the UV and visible spectral range. • Avoid fingerprints on the optically active sensor surface. If necessary, clean the components carefully with isopropanol.

	 CAUTION
	<p>RISK OF INJURY TO PERSONS</p> <ul style="list-style-type: none"> • Hot surface. Avoid contact • Replace only with LED modules with the same type number and wavelength. • Disconnect from the power circuit before servicing and replacing the LEDs. Always allow the device to cool down for 10 minutes before replacing the LEDs.

	 CAUTION
	<p>RISK OF DAMAGE</p> <p>The system heats up during operation.</p> <ul style="list-style-type: none"> • Make sure that there is sufficient air circulation at the installation site. • Fans in the device housing and in the LED modules must not be covered.

Service, repair and cleaning work may only be performed by authorized and specially trained personnel. The system must be de-energized and secured before major work (including cleaning) is performed).

Perform the prescribed adjustment, service and inspection work according to the schedule.

Only qualified electricians may carry out work on the electrical system.

Safety devices may only be removed during service and repairs if the system has previously been switched off and brought into a safe condition.

During service and maintenance work, important safety installations may no longer function. Work of this type therefore requires special care.

6 Description of the system and function overview

6.1 LedControl for Spot P, Series L and SFL

The LedControl offers the possibility to irradiate UV coatings and UV adhesives selectively. The irradiance can be set between 2% and 100%. Control is via the front display or the rear control inputs.

The following figure shows the "LedControl" control unit

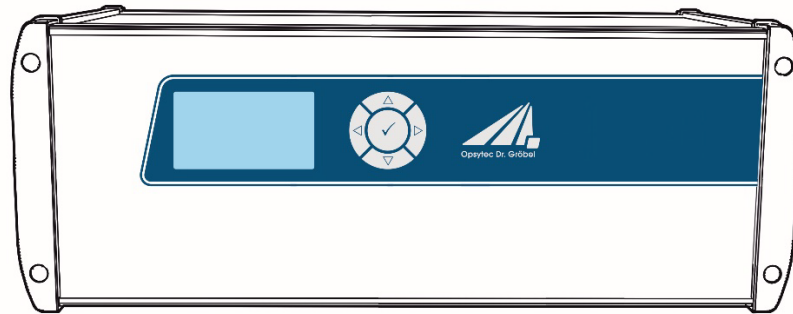

(Image similar)

General Product Description:

- UV LED light source with LED module(s)
- Peak wavelength range see nameplate
- Irradiance per channel, controllable
- Individual control of the power
- Robust, durable design with replaceable LED modules
- Optional: potential-free control signals (24 V), programming interface and analog signal inputs
- Graphic display
- Storage of operating parameters
- Timer

The following components are supplied:

- Control unit LedControl
- If applicable, UV-LED light source(s) such as UV-LED Spot P, Series L or SFL (hereinafter referred to as UV-LED or UV-LED module).
- Mains connection cable
- Contact plug
- Release cable
- this documentation



For ease of description, the above components are collectively referred to as the system.

The following components are required by the customer:

- Personal protective equipment
- Main switch and fuse for LED system
- If necessary 24 V supply (for IP54 version)

The following components can be optionally installed internally:

- Programming interface*
- Analog control interface*
- IO interface*
- Multi-IO Interface & Status*
- Power supplies*



Please note that the manufacturer of this device accepts no liability for the quality of the irradiation result of the irradiated material, as this depends on many factors. Always check the irradiation result after irradiation and adjust the irradiation if necessary.

7 LED Module L Series

The L series is equipped with high-power UV LEDs or visible LEDs. These emit intense and high-energy radiation. The UVLED module is shown below as an example (The actual design and size may vary for your UV LED module):

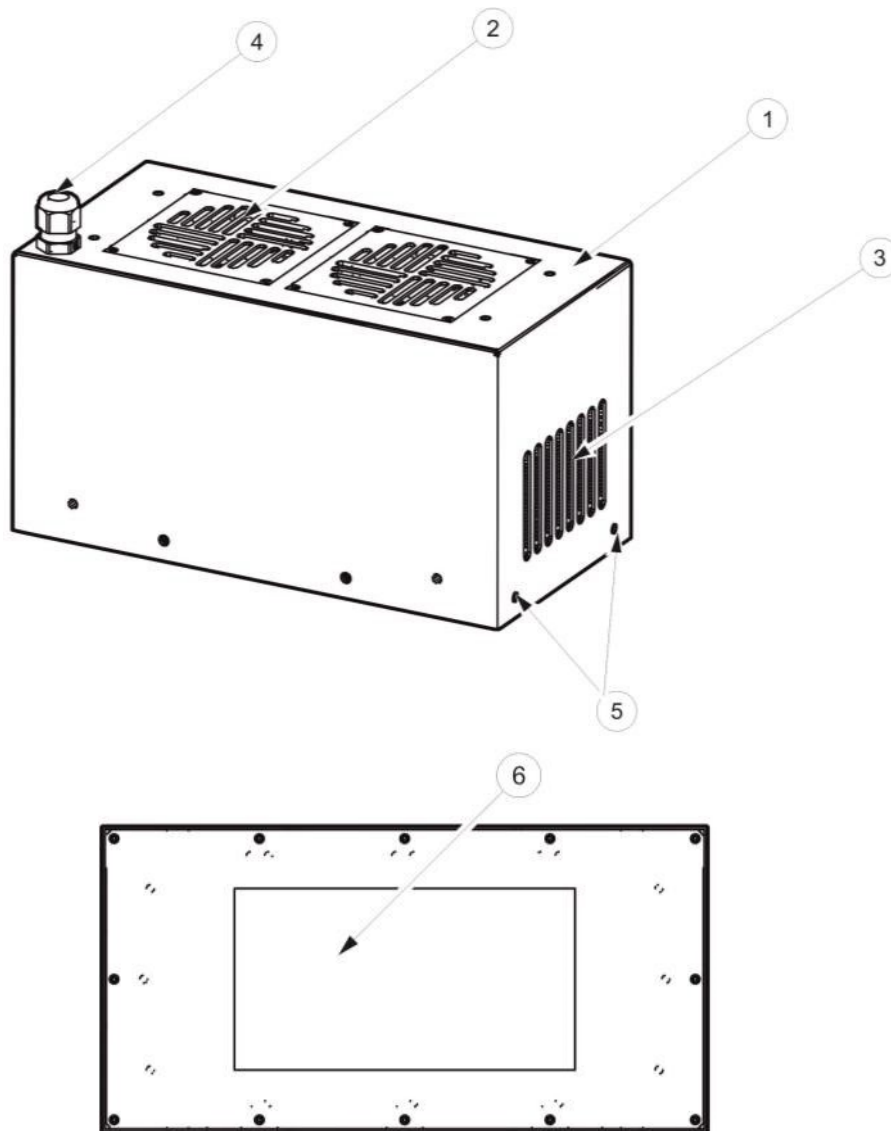

(Image similar)

Legend	
1	UV LED module
2	Exhaust air outlet
3	Supply air inlet
4	Connecting cable for LedControl
5	Module recording (see attachment)
6	Emission window

8 Commissioning

- Unpack all components and remove the packing materials.
- Position the LED modules at the desired position.
- Make sure that the air inlets and outlets of the LedControl and LED modules are not covered.
- Connect the UV LED modules to the LedControl control unit.

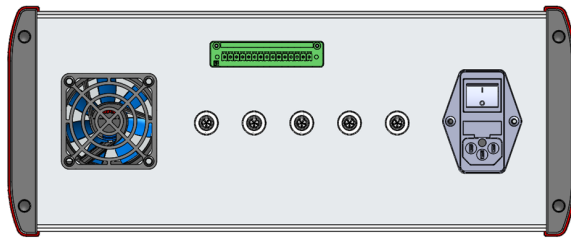

LedControl 5S

(Images similar)

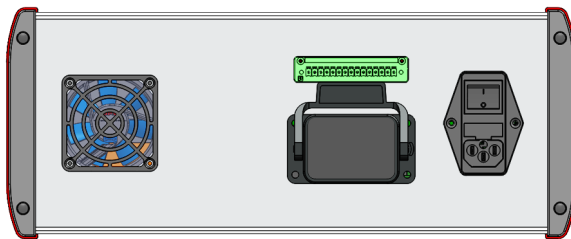



LedControl series L and SFL

(Images similar)



- For operation of the system, the contact Enable/Enable (pin 1 and 2 of the green connector) must be closed potential-free. Only then is the release for operation given. (see interface assignment)



The operator is responsible for monitoring the enable/enable contact.



	 WARNING
	<p>Risk of injury</p> <p>By closing the enable/enable contact, the operator must ensure adequate protection of workers or other persons. Note that effective protective measures are necessary to comply with the exposure limits.</p> <p>By applying the enable signal, the operator confirms that all necessary protective measures to protect the operating personnel from direct and reflected UV radiation have been implemented and are effective.</p> <p>The RELEASE contact "Release/Enable" is not a safety circuit.</p> <p>The enable/enable contact is an enable contact and does not replace a safety circuit.</p>

- If necessary, connect the trigger input according to the technical data (see interface assignment).
- If necessary, connect the optional 0-10 V control input according to the technical data (see interface assignment).
- If necessary, connect the optional 0 V/24 V control output according to the technical data.
- If necessary, connect the optional programming interface according to the technical data.
- Connect the LedControl to the supply voltage.
- Switch on the LedControl at the switch on the back.

	 CAUTION
	<p>Possible damage</p> <p>Switch off the LedControl before connecting an LED module.</p>

	 WARNING
	<p>Risk of damage</p> <p>To prevent thermal overheating, sufficient ventilation of the LedControl S/5S/16S control unit must be ensured at all times. Take special care that the ventilation openings are not covered during operation and that sufficient cooling of the UV LEDs is ensured.</p>

8.1 Connection example of the LEDCONTROL DC

For the operation of the LedControl DC and the LED module, one DC power supply unit each is required.

The output power of the 24V auxiliary voltage required for the LedControl DC is 10 W. The necessary output power of the LED systems depends on the LED system and can be approx. 20 W to approx. 2000 W. The technical data for this can be found in the data sheets of the LED systems.

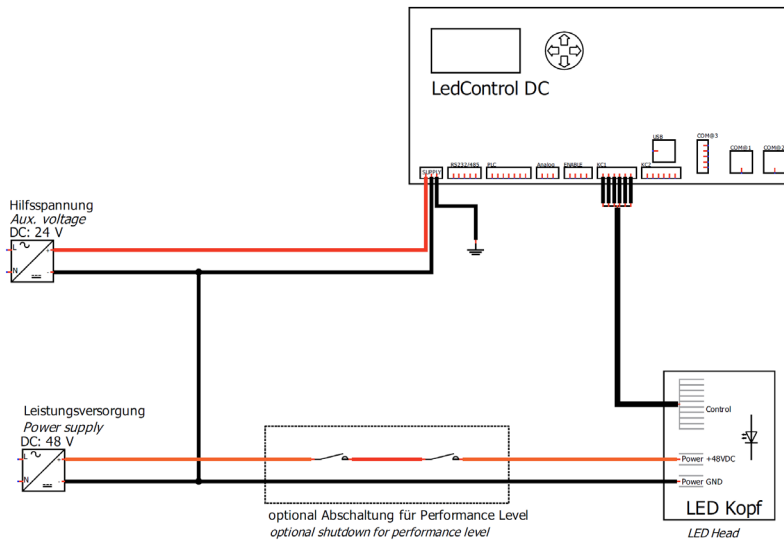

8.2 Connection example for PL KAT 4

A two-channel safety gate monitoring with automatic start is shown below as an example. The advantage over the simple isolation of the DC voltages is the monitoring of the external contactors. The connection example is suitable up to category 4, PL e (EN ISO 13849-1) or SIL 3 (EN 62061), if cross-circuits in the control to the actuator as well as in the sensor circuit can be excluded. With the PL+ extension, we supply all components fully assembled for easy system integration.

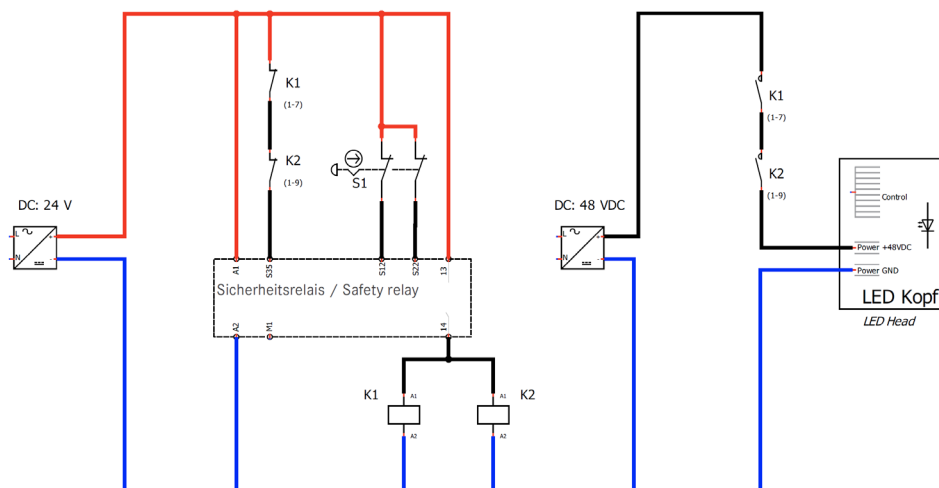

9 Operation

The LedControl is operated via five keys. These are located on the front panel to the right of the display. The keys and the function assignment are shown below:

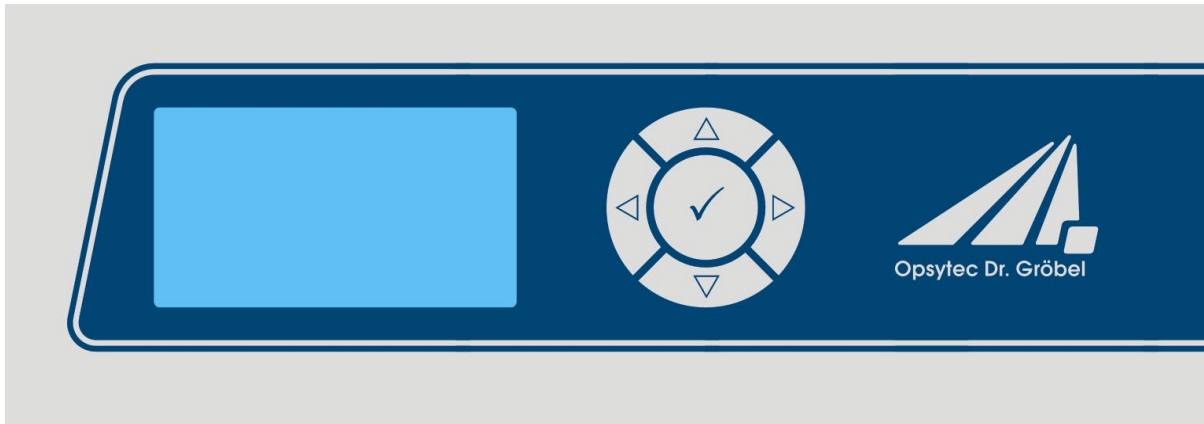

Key	Function
△	Up / LEDs on
▽	Down / LEDs off
◁	To the left / power down
▷	To the right / power high
✓	Temperature / power display

After starting the device, the logo first appears on the display. Then the device is in standby and the main menu is displayed. The menu items in the main menu depend on the settings. For example, the menu items are only displayed if the corresponding mode has been selected.

Select the active menu item using the \triangle and ∇ keys. The selected menu item is highlighted in black and displayed inverted. Use the \triangleleft and \triangleright keys to change values and select the operating mode. The selected menu item is highlighted in black and displayed inverted.

The LedControl has three operating modes:

- Continuous operation
- Timer mode
- Remote operation* (via programming interface)

The menu items depend on the settings. For example, the "Irradiation time" menu item is only displayed if the corresponding timer mode has been selected.

9.1 Switch on

Switch on the control unit at the switch on the back.





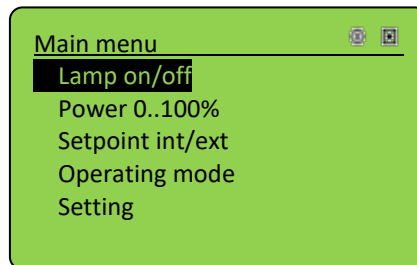

After starting the device, the logo first appears on the display followed by a short self-test.



During the self-test, the LED modules and the enable signal are checked and the status is displayed. Afterwards, the device is in standby and the settings menu is displayed.



In the upper right corner, the state is displayed, meaning:

-  LED module on
-  LED module off
-  External setpoint for LED power (optional)
-  Internal setpoint for LED power
-  Timer mode
-  Continuous operation

9.2 Switch off

Procedure:

1. Switch off the LED system at the switch on the back.



The operating mode and the set power remain permanently stored. After a restart, the last operating operating mode is called up.



Powers and modes set in remotemode* are not transferred to "normal operation" and are not saved when the device is switched off.

9.3 LED On / Off

When the LED is on, the status screen is displayed. Example:

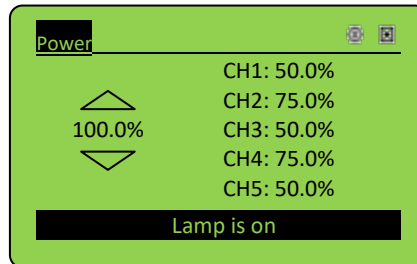

The status screen displays the current powers, the set operating mode, the internal or external control and error messages.

From the status screen, press the◀ key to return to the main menu.



The LED is switched off by pressing the key (✓).

9.4 Change the power

Select the "Power 0..100%" menu item in the main menu.

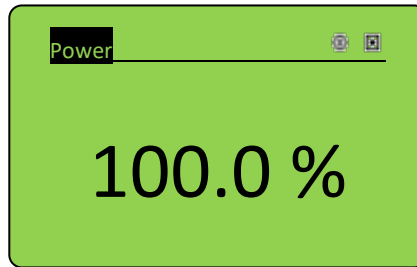

If your LEDControl is designed for several LED modules, select "all channels" or "single channel" in the submenu.

All channels:

The power can be set to the desired value using the or keys ∇ and \triangle . Confirm with OK (\checkmark) to return to the main menu.

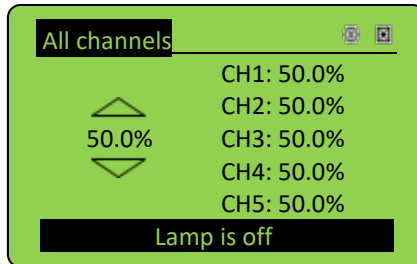

Single channel:

The status screen displays the current powers, the set operating mode, the internal or external control and error messages.

Select the desired channel (○) by using the and keys ∇ and \triangle confirm with \checkmark .

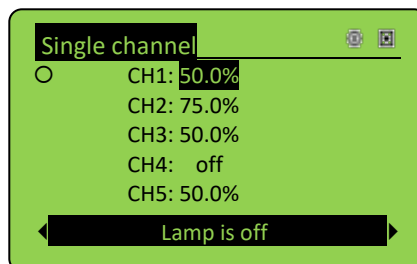

The selected menu item is highlighted in black and displayed inverted.

The and keys can now be used to change values.

Press (\checkmark) to return to the LED selection.

Press to return to the channel selection. In the channel selection, you can use the keys \triangleleft or \triangleright to display additional channels (e.g. 6-10, 11-15).

From the status screen, press the \triangleleft key to return to the main menu.



With the key < the channel can be switched off. With the key > 100% is set.



Settings below 2% and above 100% are reset to the limit values.

Reset:

All channels can be set to 0% or 100% simultaneously.



With the single channel setting it is possible to set several LED modules to different powers. When the LED modules are switched on (via "Lamp on/off"), the power of all individual channels is displayed. In addition, a master power is displayed. If this is changed, the channel powers change as a percentage of the power set in the individual channel setting.

Example: CH1 is set to 40%. The master power is set to 80%. So in the main view CH1 will show 32%.

9.5 Timer mode / irradiation time

In the "Operating mode" menu, select Timer and return to the overview menu.

Now the timer main menu is visible.

In timer mode, the LED is started for the preset exposure time and then goes out again automatically. The exposure can be canceled by pressing the (✓) key.

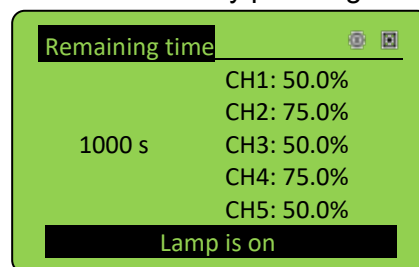

In timer mode, the power cannot be varied during irradiation.



Pressing the (✓) key cancels the irradiation.

The irradiation time and unit can be set for the timer mode. This setting can be found in the main menu.

If the "Irradiation time" menu item is not displayed, switch to the "Timer" operating mode.

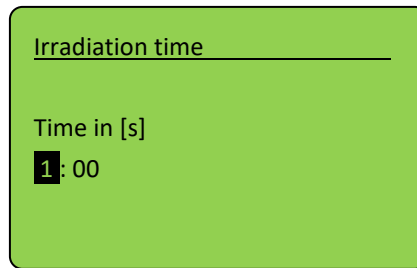

Here, the decimal place is selected with the ◀ or ▶ key and the time is set to the desired value with the △ or ▽ keys. Confirm with OK (✓) to return to the timer main menu.

Times from 0.1 sec to 99:59 h can be set.



The timer is started with the key or the positive edge of the trigger signal. If your LedControl is equipped with several trigger inputs, only the trigger input CH1 controls the timer.



If the timer has not yet ended, it is restarted/stopped by pressing the key again or by the external trigger signal.

9.6 Settings in the main menu

9.6.1 Internal and external setpoint*

In the "Setpoint int/ext" menu, the power control can be changed from the internal setpoint to the external setpoint. With the external setpoint, the power follows the analog control voltage at the rear terminals.

9.6.2 Operating mode

In the Operating mode menu, it is possible to switch between continuous operation and the timer mode.

9.7 Settings in the settings menu

The following chapter explains the functions in the settings menu.

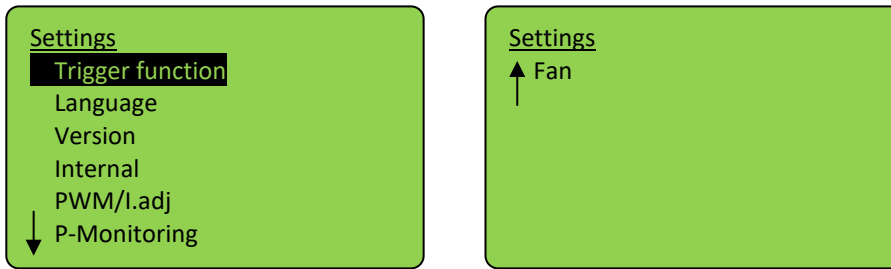

In the settings menu and all submenus, use the ▾ and △ keys to select the active menu item. Use the key ✓ to confirm the selected menu item. Use ◀ to return to the previous menu.

9.7.1 Trigger function

This menu item allows you to set the trigger function. The following options are available:

Continuous operation	Trigger Trigger + Hold (default)	In continuous operation, the LED responds to the signal at the trigger input. The application of the trigger ("positive edge") starts the irradiation. A negative edge at the input terminates the irradiation.
Timer operation	Trigger	The application of the trigger ("positive edge") starts the irradiation for the set duration. Another positive edge or the expiration of the time ended the irradiation.
Timer operation	Trigger + Hold (default)	The application of the trigger ("positive edge") starts the irradiation for the set duration. A negative edge or the expiration of the time at the input terminated the irradiation.

9.7.2 Settings, menu language setting

The menu languages German and English are available. The setting is made in the "Setting" menu, then "Language".

9.7.3 Version

Shows the installed firmware version:

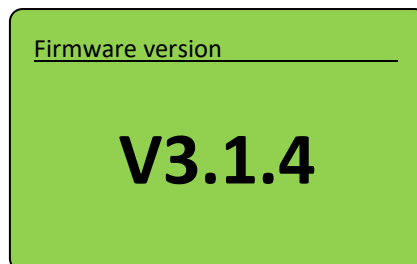

9.7.4 Internal

No user settings are provided in this submenu.

9.7.5 PWM/I.adj*

This submenu is used to switch between PWM control and I adjust, i.e. current control.

9.7.6 Power monitoring*

Power monitoring is an option to measure the total power of the LED modules [in W]. In addition, an error will be output when the power falls below/exceeds the limit.

The total electrical power is shown in the status bar in the display and can be output via the programming interface*.

In the menu "P-Monitoring" the built-in power measurement can be adjusted to the respective UV LED module.



Please note that the UV LED modules must be connected before switching on the LedControl.

For adjustment select the subitem "Adjustment". Confirm the warning "Power of modules up to 100%" with OK. Perform the adjustment for all channels.

Please note that at the beginning of the adjustment the power of the modules is set to 100% and 10%! The LEDs are active during the adjustment!

⚠ WARNING	
	<p>Danger from UV radiation and intense light.</p> <p>The LEDs are active during adjustment.</p> <p>The LED system is equipped with high-power LEDs. There is a risk of photochemical or thermal damage to the eye, retinal damage and burns. Visible (blue) light can cause photochemical damage to the eye. If necessary, use suitable protective goggles when operating the unit. The operating personnel must be trained appropriately.</p>

During adjustment, current and module power are displayed, which are later added together to give the total power.

In the submenu "Tolerance" you can set the tolerance of the power monitoring in percent. An error will be output when the power falls below/exceeds the tolerance. The error can be queried via programming interface*. The LEDs remain active even in the event of an error.



There are two conditions for performance monitoring to check:
Each channel must have a set power greater than 40%.
The absolute power of a channel must be above 1.5 times the absolute power of the tolerance [in W].

Example: The total power of the LED modules is 450 W. The tolerance is set to 10%. Then the power of a channel must be greater than 67.5 W, otherwise the test is deactivated and no error is output.



Adjustable tolerance values 5% to 20%.
Recommended tolerance value 10%.

9.7.7 Fan

For LED modules from series L type M the fans can be controlled. There are three setting options.

1. Fan speed
 - a. In the Exposure submenu item, the speed that the fan should have during the exposure is set.
 - b. In the submenu item Basic, the speed that the fan should have in standby is set.
2. Follow-up time:
 - a. The fan continues to run for the set time after exposure at the speed set during exposure.
3. Temperature threshold:
 - a. The temperature threshold can be switched on and off. If it is switched on, the fan runs above a set temperature threshold at the speed set during exposure.
 - b. After switching on the temperature threshold, the threshold temperature is queried. This can be set as desired.



From 55 °C, the fan runs at maximum speed.
Above 80 °C, the LED module switches off to prevent overheating.

9.8 Leveling - Level multiple LED segments*.

The Leveling option allows a head with several LED segments to control them centrally on the one hand and to align the individual LED segments with each other on the other.

The leveling option is used for systems where leveling of the individual LED strands is possible or necessary.

Such an adjustment can be useful, for example, if an LED segment has been replaced and therefore achieves a higher irradiance locally.

For parameterization, proceed as follows:

Comparatively measure the irradiance of the LED segments at maximum power setting.

Then determine the LED segment with the lowest irradiance and reduce the power setting of the other LED segments to this value accordingly.

To do this, select Main Menu->Settings->LED Leveling.



The lowest power LED should always be set to 100%.

The individual powers of the LED segments are set in the menu and cannot be adjusted during normal operation. This means: An LED system with leveling option behaves like a single-channel system during normal operation and via programming interface.

The operation is similar to the other configurations with multiple channels or LED heads. If the leveling option is available, the setting "Power 0..100%" is available in the main menu to change the power for all segments at the same time.

During operation, just as in LED systems with several LED heads, the individual power values of the channels are displayed. These are calculated from the set individual values and the set master power.

Under Settings LED Leveling gives the submenu for sum, single channels and reset as for multi-channel systems.

10 Remote operation - programming interface *

The LED system can be controlled via the programming interface* on the rear. Depending on the selected option, the connection is designed as USB, RS485 or RS232 connection.

Operation via the programming interface is called remote and is visualized on the display.

Remote operation cannot be selected via the menu. Operation on the device is not possible in remote mode. Settings made via remote are not transferred to normal operation.



The remote mode is selected by applying the control voltage +24V to the remote PIN. The control voltage must be applied when starting the LedControl.

After successful initialization, the remote operation is displayed as follows:



The communication takes place as ASCII communication, which is shown below with the example "Switch on":

- **Controller transmits:** LOnOff:1! {CR}{LF}
- **LedControl answers:** LOnOff: 1 (CRC) {CR}{LF}

The LedControl only transmits when prompted by the controller.
Only one command/query is processed at a time.



The communication is available after the initialization of the LED system. Depending on the version, initialization may take a few seconds.

10.1 Definitions

- Baud rate: 115200 baud
- Parity: None
- Data bits: 8
- Stop bit: 1

10.2 Type definition

- **BOOL:** ASCII representation of the value: "1" = TRUE; "0" = FALSE
- **INT:** ASCII representation of the value: 12345
- **FLOAT:** ASCII representation of the value: 1.2345E+01
- **STRING:** ASCII representation of an alphanumeric string
- **ARRAY[1..8] of** Separated by {Tab}

Unused digits in INT or FLOAT specifications must be written with "0".
E.g. default power with 50.1% corresponds to 050.0 as transfer value.

10.3 Command structure specifications

- Separation of answers and values is done by {Tab}
- Command end by {CR}{LF}
- Command and data separation by ":" ({tab} after colon)
- Request for data is executed with "?" at the end (No {Tab} between end command and ?)
- Commands including request for data are executed with "!" at the end ({Tab} between end command and !?)
- For data that can be set (!?), the command (without data) is sent with ? to query the data. Example "LOnOff":
 - Set: LOnOff: {Tab}1{Tab}!?
 - Queries: LOnOff?
- Command length limit of 200 characters
- Non-understandable commands are confirmed by:
 - NACK:No such command!{CR}{LF}

10.4 Error handling / timeout

- Timeout for command processing; default value: 200 ms
- Time interval for retransmission; default value: 200 ms
 - Error codes can be queried with the LError? command.

10.5 Command overview

Usage	Command	Reply	Value range
Query serial number	LSerialNo?	LSerialNr: LedControl() (CRC)	STRING
Query type number	LType?	LType: LedControl() (CRC)	STRING
Firmware query	LFirmware?	LFirmware: LedControl() (CRC)	V00.00.00 - 99.99.99
Query number of channels	LAnzahlCH?	LAnzahlCH: # (CRC)	1-16
Query connected channels	LChPresent?	LChPresent: CH1() ... CHxx() (CRC)	1 = LED connected 0 = LED not connected
Set power	LPowerSet: CH1() ... CHxx() !?	LPowerSet: CH1() ... CHxx() (CRC)	002.0-100.0 [%]
Query performance	LPowerSet?	LPowerSet: CH1() ... CHxx() (CRC)	002.0-100.0 [%]
Led on/off	LOnOff: X!?	LOnOff: X (CRC)	X = 1 = on X = 0 = off
Query Led (all)	LOnOff?	LOnOff: CH1() ... CH8() (CRC)	1 = LED on 0 = LED off
Channel on/off	LSelect: CH1() ... CH8() !?	LSelect: CH1() ... CH8() (CRC)	1 = LED selected 0 = LED deselected
Query channel	LSelect?	LSelect: CH1() ... CH8() (CRC)	1 = LED selected 0 = LED deselected
Parameterize trigger	LTriggerOnOff () () !?	LTriggerOnOff: ON() ... HOLD() (CRC)	ON = 1 trigger active ON = 0 Trigger not active HOLD = 1 Trigger&hold active

			HOLD = 0 Trigger&hold not active
Electrical power sensing head	LPowerCons?	LPowerCons: (CRC)	0000-9999 [W]
Query temperature	LTemperature?	LTemperature:\txx (CRC)	00-99 [°C]
Query the number of internal channels (only with Leveling option)*.	LLevelCount?	LLevelCount: X (CRC)	X=number of channels
Query the setting of the channels (only with Leveling option)*.	LLevelSet?	LLevelSet: CH1() ... CHxx() (CRC)	002.0-100.0 [%]
Set the setting of the channels	LLevelSet: CH1() ... CHxx() !?	LLevelSet: CH1() ... CHxx() (CRC)	002.0-100.0 [%]
Query error of the LED	LError?	LError: CH1() ... CH8() (CRC)	000 - 999 (error code)
Reset (identical to Disconnect voltage)	LResetSystem!	LResetSystem: (CRC)	N/A
Command not recognized / faulty transmission	N/A	NACK:No such command!	N/A



The adjustment of the power measurement and takes place only locally at the LedControl due to the active LEDs.



The parameterization of the fan speeds and the overrun only takes place locally at the LedControl due to the heat dissipation.

10.6 Checksum

All responses that are sent with data content must be provided with a checksum (CRC-16). This is evaluated accordingly for correctness. The checksum is always at the end of the message, separated by TAB, which is part of the data to be checked.

The checksum is defined as follows:

Type: CRC-16
CRC Polynomial: 0x8005
Init CRC value: 0x0000
Final XOR value: 0x0000
Reflect data (byte): No
Reflect CRC (word): No
Example (ASCII): 123456789
Result: 0xFEE8

The checksum is omitted from the commands to the LedControl.

In the answers, the checksum is always at the end. Example:

Command to set all LEDs to X% power (spaces are tabs):

```
LPowerSet:    017.2 033.7 033.7 033.7!?
```

Answer (spaces are tabs):

```
LPowerSet:    017.2 033.7 033.7 033.7 0x1CDE
```

Further examples are given below. With a different number of channels, correspondingly more or fewer channels are to be provided in the input and the output, therefore the checksum is only given here as an example.

```

LAnzahlCH?
LAnzahlCH: 40xCRC-16
LChPresent?
LChPresent: 11110xCRC-16
LTriggerOnOff: 00 !?
LTriggerOnOff: 000xCRC-16
LSelect: 0110 !?
LSelect: 01100xCRC-16
LPowerSet: 000. 0033. 7050. 1000.0 !?
LPowerSet: 000. 0033. 7050. 1000. 00xCRC-16
LOnOff: 1 !?
LOnOff: 00x9908
LPowerSet?
LPowerSet: 017. 2033. 7033. 7033.70x1CDE
LChPresent?
LChPresent: 11110x7BB3
LSerialNo?
LSerialNo: 860609-00010x0708
LFirmware?
LFirmware:. v2.07 0x21D6
LTriggerOnOff: 0 0 !?
LTriggerOnOff: 000x9F92

```

```

LAnzahlCH?
QuantityCH: 40x0AA1
LOnOff?
LOnOff: 01000x9908
LSelect: 0000 !?
LSelect: 00000xEA6

```

Notes for remote operation:



Individual functions are not available for every firmware. Therefore, always ask for the firmware version.



The number of channels must be exact, otherwise the command will not be accepted.

10.7 Initialization

After initialization, the following commands must be sent:

```
LChPresent?
LSelect!
LPowerSet: ...
LOnOff or LTriggerOnOff
```



Only after the above commands the LED system is ready for operation and can be used.

10.8 Example program for starting the LEDControl

Spaces are {TAB}.

This example shows a Led Control with 5 channels.

```
LFirmware?                //Firmware query
LType?                    //Query type number
LSerialNo?                //Query serial number
LAnzahlCH?                //Number of existing channelsquery
LChPresent?               //Query connected
channels
LTriggerOnOff:  00      !?          //Trigger set
LPowerSet:  078. 3012. 2058. 3094. 6002.0      !? //set desired power
LSelect:  11111 !? //Select channel
LOnOff:      1      !?          //LED module switch on
LOnOff:      0      !?          //LED module switch off
LError?                //Query error
```

Example program sections for different functions of the trigger

11 Fehler / Error

Error codes can be queried via the "LError?" command.

Only the last error is displayed.

Error confirmations always with NACK:No such command!

The error code is then displayed in the error register.

If a command is sent correctly, the error is cleared.

general	Error number	Description
no error	000	There is no error

Error	Error number	Description
	100	Switch on without enable/enable
	101	No head detected
	102	Temperature too high (temperature switch)
	103	Temperature too high (temperature sensor)
	104	Power outside tolerance*



The electrically absorbed power of the head* can be queried via the LPowerCons? command. Error is output, irradiation is not stopped.

Data reception error	Error number	Description
LPowerSet	400	Error when receiving data from controller Receive string has the wrong length (message to all)
LPowerSet	401	Character error
LPowerSet	402	Value range > 100.0
LPowerSet	403	Value range < 2.0
LSelect	500	Error during data reception from controller Receive string has the wrong length (message to all)
LSelect	501	Character not "0" or "1"
LedResetAll	900	Reset was triggered but not / not yet performed
Command not recognized	999	Data was received but no command was detected

12 Software - LedControl Remote for programming interface*.

The "LedControl Remote" software is used for testing and controlling the LedControl control unit with the PC. The software enables:

- LED channels on and off
- LED channels to be switched on and off
- To change the power (of the LED modules)
- To use a timer for the lamps
- Save and load settings as presets (software side)
- Change the internal trigger mode (Digital Trigger, Trigger and Hold, and Trigger Switch).

The software is divided into three areas. The *Menu* area displays the device information. The middle area *Device Control* is used for control and monitoring. The bottom Log area shows the commands & responses sent via the COM interface. At the bottom of the software there is a bar with various functions.

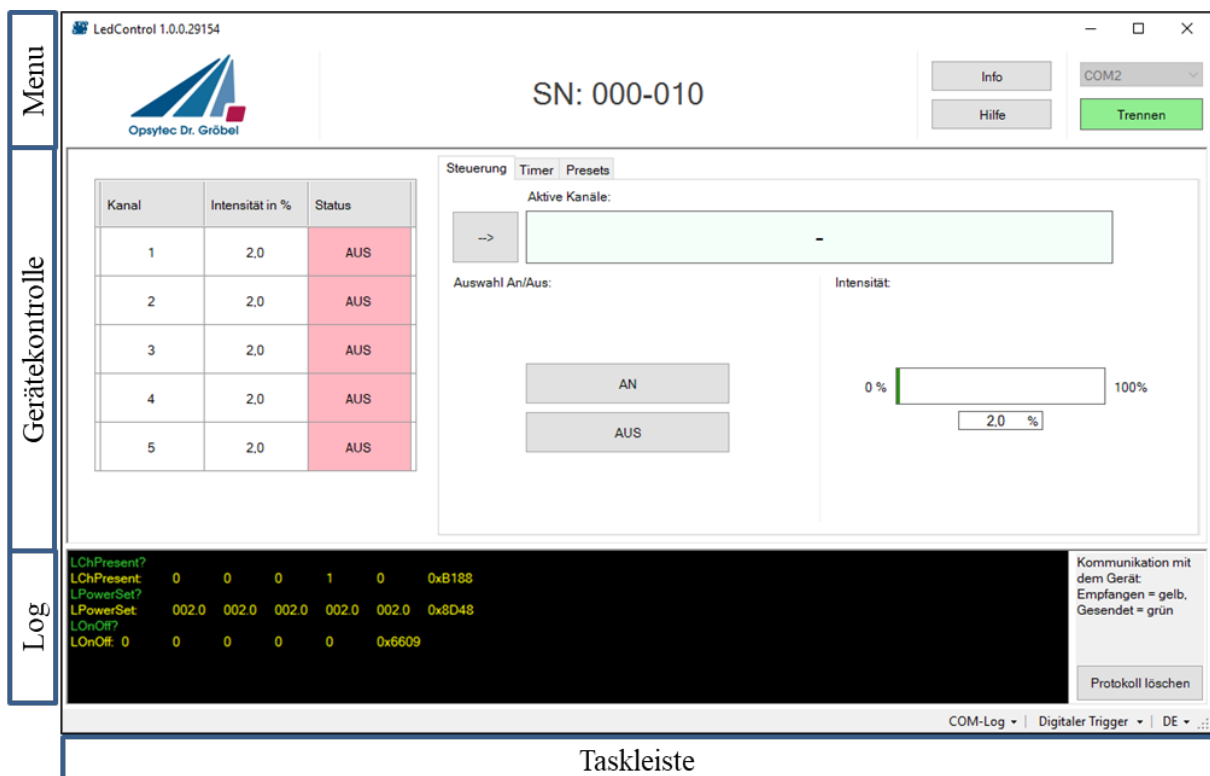

The areas are described below:

Menü

SN: 000-010 Displays the serial number of the connected LedControl

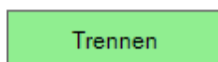

Connects or disconnects the LedControl from the PC and displays the connection status:

- Connected (green)→ disconnects the connection to the LedControl
- Not connected (red)→ connects the LedControl

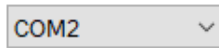

Listing of all COM ports located on the PC

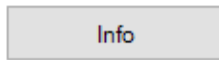

Opens an information window with:

- Software version number
- Firmware
- Serial number
- Type number
- Number of LED slots

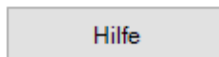

For more information

Equipment control

The middle area of the software is used for Led Control control and monitoring. Here an overview table with all LED channels is displayed.

The table is used to select the channels, to display the currently set LED intensity and to display the channel status:

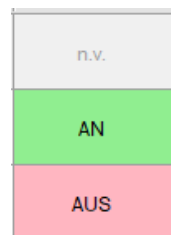

n.v. unconnected channel,

AN activated channel and

AUS channel not activated.

From the right side there are various control functions for the LedControl.

This includes the control of the LED channels, the programmable timer and storable presets. The functionalities can be switched via the different tabs.

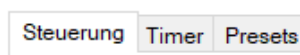

More about the functions in the respective chapters.

Log

The lower area shows the commands sent to the device via the COM interface (in green) and the responses received from the software (in yellow). By clicking on "Clear log" the history is deleted.

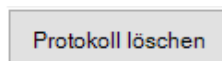

Software taskbar

At the bottom of the software there is a bar with various functions: The right area of the bar is used to display errors and messages.

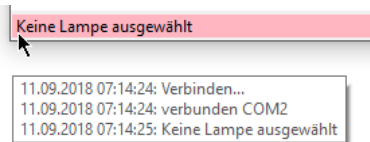

Errors and messages appear in the display for 3 s, errors are highlighted in red. The last ten messages are displayed here when the mouse pointer hovers over them.

The left area is used to change settings

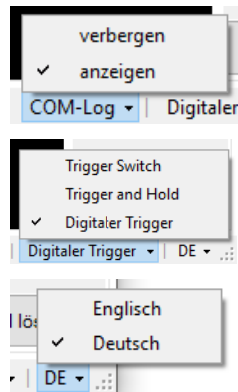

The COM log area can be made invisible here by "COM log" -> "hide" and visible again by clicking on "show".

The devices internal trigger mode can be switched here

The language can be changed here between German and English

12.1 Install software

For the installation, proceed as follows:

- Uninstall any old versions of the software first.
- If necessary, disconnect the LedControl from the PC.
- Start the installation with "LedControl Remote Setup.exe" in the software USB stick. Follow the instructions of the installation program.
- After completing the installation, connect the LedControl to the PC.
- If the driver installation is not automatic, install the Setup.exe in the folder "USB drivers".

12.2 Working with the software

Make sure that the LedControl is connected to the PC and switched on. Please note that the device must be in remote mode so that the display reads REMOTE.



Remote operation is selected by applying the control voltage to the remote PIN. The control voltage must be applied when starting the LedControl.

Start the "LedControl Remote Software".



After starting the software, the LedControl must be connected:

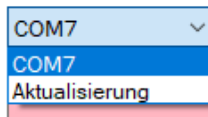

If the LedControl is properly connected to the PC, the COM address appears at the top right. All COM ports on the PC are listed here. If several devices are connected, the correct address must be selected.

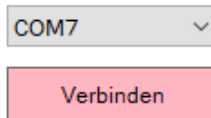

Click on "Connect" to check whether the device can be connected and responds properly to commands. Subsequently, all internal parameters such as the serial number are queried.



If there is no error, the button turns green and indicates "Disconnect". The software is unlocked and can now be operated.



If no COM address is displayed, or if the correct COM address is not displayed, the list of addresses can be updated by clicking Connect if "Update" is selected.

If the connection to the LedControl is to be disconnected, click the "Disconnect" button. The connection will be disconnected, when reconnecting all software settings will be kept and the device settings will be reloaded.

If the LedControl is disconnected without previous disconnection via the button, the software locks after 5 s at the latest.

12.3 Activate LED channels

To control one or more LED channels, they must first be activated and selected in the table.

Kanal	Intensität in %	Status
1	2.0	AUS
2	2.0	AUS
3	2.0	AUS

In the table, select the desired channels by clicking on them. Multiple channels can be selected by clicking and dragging or by using the Shift key. Selected channels are highlighted in blue.

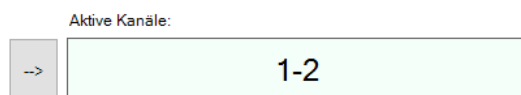

By clicking the arrow button, the selected channels are activated and selected in the device. The activated channels are listed in the text field.



Tip:

Double-click on the header of the table to select all channels, and single-click to deselect all.

Double-clicking on a channel or pressing Enter activates it directly.

12.4 Switching LED channels on and off

One or more LED channels can be switched on or all channels can be switched off in the "Control" tab. The desired channels must be activated in the software and selected in the device.

Auswahl An/Aus:

By pressing "ON" all activated channels are switched on.

By pressing "OFF" all channels are switched off regardless of which ones are activated.

Kanal	Intensität in %	Status
1	2,0	AN
2	2,0	AN
3	2,0	AUS

The status of the channels is displayed in the table.



Tip:

If only one channel is to be switched off, it must be excluded from the active channels. By clicking "On" only the active channels are switched on, all others are set to the off state.

12.5 Change intensity

The intensity of one or more channels can be changed in the "Control" tab on the right. The intensity is given as a percentage, with 100% being the maximum intensity and 2% the minimum possible intensity. The intensity can be changed either for each channel individually and absolutely, or for several channels proportionally. Switching on the lamps is optional, the intensity can also be changed when the lamps are off.

Change the intensity of a channel:

The channel to be changed must be activated in the software. When a channel is activated, its intensity is transferred to the surface. The intensity is changed by moving the slider, turning the mouse wheel or typing in the value. A typed value must be confirmed by Enter.

The changed value is transferred to the table and sent to LedControl.

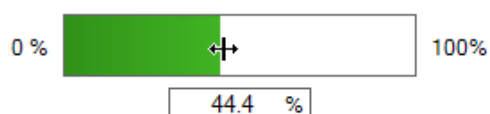

Change intensity of multiple channels:

If more than one channel is activated, a master slider appears. The master slider can be changed by moving the slider, turning the mouse wheel or typing in the value. The intensity of the activated channels changes in percentage to the master. The changed value is transferred to the table and sent to the LedControl.

Master

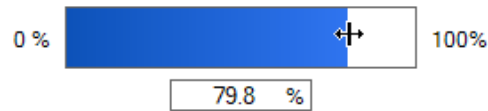

Tip:

The multiplier with which the intensity is changed with the mouse wheel can be changed by typing the number when the slider is in focus.

12.6 Program timer

With the software programmable timer the LEDs can be switched on and off in intervals of at least 0.1s, switched on after a time or switched off after a period of time. To use a timer, the "Timer" tab must be activated and at least one LED channel must be activated.

Einstellungen:

"Anzeit": sec.

"Auszeit": sec.

Wiederholungen: Unendlich

Start:

Anzeit	is the time the LED is on before it goes off. If this value is 0, the LED will not turn on until the off time has elapsed.
Time out	is the time the LED is off before either the timer ends or it turns on again according to the repetition. If this value is 0, the LED will go off after the on time has elapsed and the timer will stop.
Repetitions	are the cycles how often the LED is switched on and off again. Either a finite number of cycles can be specified or an infinite number. This value is only valid if none of the times is 0.

Start timer	starts the timer. A loading bar appears which shows the progress of the timer.
Cancel	opens only when the timer is running and cancels it.

12.7 Use and manage presets

To use or save a preset, the "Preset" tab must be selected. All saved presets of the respective LedControl are listed here. If no preset is stored, the table is empty. The presets are saved as text file on the PC under:

[...\Documents\LedControl Remote Software\Presets.txt](#)

A preset contains the following information:

- Which channels are selected
- the intensity of the respective channels
- which trigger mode was used
- the setting of the timer
- the serial number of the LedControl
- the storage date.

Name	Kanäle	Intensität [%]	Trigger	Timer	Seriennummer	Speicherdatum
Preset1	1-5	044.9; 063.1; 030.3; 072.2; 007.6;	Digital trigger	0,1s/ 0,1s/ 1	000-010	09/10/2018 1...
Preset2	1-5	006.8; 009.6; 004.6; 011.0; 002.0;	Digital trigger	1,3s/ 1,3s/ I	000-010	09/10/2018 1...
Preset3	1	006.8; 009.6; 004.6; 011.0; 002.0;	Digital trigger	1,3s/ 1,3s/ I	000-010	09/10/2018 1...

Neu Löschen Laden

Laden

Loads the selected preset into the control surface, the channel selection and the intensity of the preset are set directly in the LedControl.

Löschen

Deletes the selected preset irrevocably. Presets can only be deleted, not changed.

Neu

Opens an extra window to save a preset.

Saving a preset

A preset is saved with the parameters that are currently set in the user interface. At least one channel must be selected before a preset can be saved with "New".

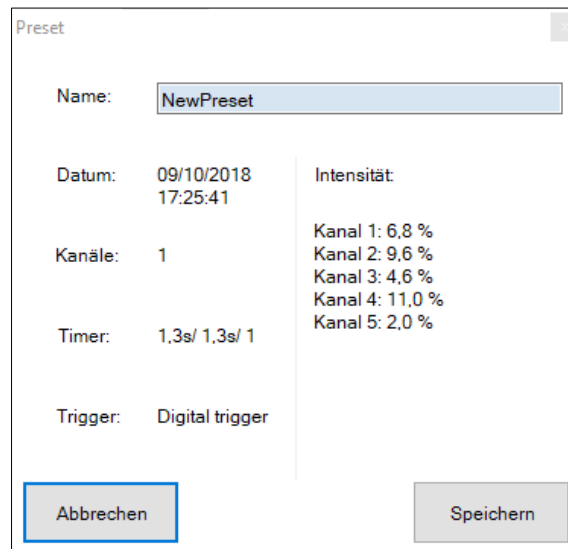

In the "Preset" window, the settings with which the preset is saved are displayed. Before clicking the Save button, the name of the preset must be set. The preset name may only be used once and must not contain a space, semicolon or line break.



Tip:

Right-click on the table to hide columns and display all presets, regardless of LedControl.

12.8 Trigger modes

The internal trigger mode of the LedControl can be switched in the lower bar.

The trigger modes differ in how the channels are switched on, either by software via the LOnOff command (digital trigger) or via an external trigger input (trigger switch or hold). If one of the external triggers is selected, the channels can no longer be activated/deactivated on the software side. The corresponding functions are then disabled.

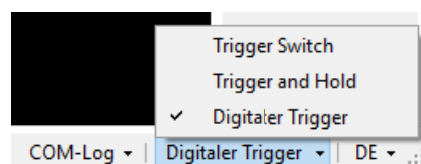

13 Technical data



The pin assignment for special versions may differ and can be found in the "Technical Drawing" appendices.

General data	
Ambient temperature	+5 to 40 °C
Storage temperature, approx.	-10 to +60 °C
Humidity	0% to 80% rel. humidity
Body type, LedControl	Desktop device
Mounting position UV LED module	any
Dimensions, control electronics 1S type XS	250 x 100 x 185 mm (W x H x D)
Dimensions, control electronics Series L Type M, L, XL	357 x 144 x 304 (W x H x D)
Maximum housing temperature	<60 °C (UV LED module)
Cooling control	Air cooling
Display	Graphic display, 128 x 64 px

Mounting position, minimum distances	
Body position LedControl	horizontal
Minimum distances, top	4 cm
Minimum distances, lateral	4 cm

Connections	
Mains voltage and frequency	100-240VAC / 50/60 Hz
Maximum input power	See nameplate
UV LED module connection	Rear Harting connector or 5-pin connector (depending on variant)
Fuse	See nameplate
I/O connection	Phoenix Contact MC 1.5/15-STF-3.81 Order number: 18 27 83 9
Control input, trigger	24 V, input current < 20 mA High level >15 V, positive logic Low level < 12 V
Programming interface*	USB, RS485 or RS232

USB connection / hardware software requirements*.	
PC requirements	At least Intel CORE i3, 2 GB Ram, >40 Gb HDD
Operating system	Windows 7 or 10 with .NET Framework >4.0

13.1 Interface assignment

Interface assignment , I/O connection*		
Interface, rear control	Signal	Function
Pin 1	Enable OUT	Enable / Enable
Pin 2	Enable IN	
Pin 3	+24 V output	Auxiliary voltage (max. 50 mA)
Pin 4	GND	
Pin 5	Dim-IN*	0..10V Analog input
Pin 6	GND	
Pin 7	Trigger IN	Trigger input (+24 V)
Pin 8	Status OUT	Status output (+24 V)
Pin 9	ERROR	Low: ERROR (0 V) High: OK (+24 V)
Pin 10	RX+*	RS485/RS232
Pin 11	RX-*	RS485
Pin 12	TX+*	RS485/RS232
Pin 13	TX-*	RS485
Pin 14	GND	
Pin 15	REMOTE*	REMOTE active (+24 V)



Remote operation is selected by applying the control voltage to the remote PIN. The control voltage must be applied when starting the LedControl.



When using the RS232 interface option, only RX+ and TX+ are required.

13.2 Control

Control	
Analog input*	0 .. 10 V
LED power*	0 V = 0%, 10V = 100%
Trigger input	Connect from trigger input to +24V triggers a trigger.
Continuous operation	Depending on the trigger selection (Trigger or Trigger&Hold), the lamp is switched on when a trigger signal is detected or when it is permanently present.
Timer operation	In timer mode, external triggering is also possible.
Internal / external*	Switching between rear input and front condition
Timer	0.1s - 99 days



Use control cable with minimum cross-section of 0.25 mm².

Communication *	
Type:	RS485, 4 wire, RS-232, 2 wire
Baud rate	115200 baud
Parity	None
Data Bits	8
Stop bit	1

CRC checksum *	
Type:	CRC-16
Parameter	CRC Polynomial: 0x8005 Init CRC value: 0x0000 Final XOR value: 0x0000 Reflect data (byte): No Reflect CRC (word): No

13.3 LED modules

LED modules	
Type	See nameplate
Peak wavelength	See nameplate
Adjustable power	2 - 100%
Dimensions LED module, approx.	see drawing

Dimensions, irradiation field, approx.	see drawing
Cooling	Air cooling
Classification	Risk group 3 according to DIN EN 62471:2009-03
Irradiation field	See data sheet or technical drawing
Dimensions, LED module	See data sheet or technical drawing
Recording LED module	See data sheet or technical drawing

	⚠ WARNING
	<p>Fire hazard!</p> <p>An extremely high irradiance, which can ignite combustible materials in case of permanent irradiation, is reached at the output of the LED modules. Remove all combustible materials and observe the irradiation time and material temperature.</p>



Contact the manufacturer if the technical drawing is no longer available.

13.4 Cooling of the LEDs

	⚠ WARNING
	<p>Risk of injury!</p> <p>The maximum housing temperature can reach > 60 °C. In continuous operation these high temperatures can be reached and there is a risk of skin burns on contact.</p>

Cooling L series

The UV LED requires active air cooling / convection.

To prevent thermal overheating, sufficient ventilation must be ensured at all times. Take special care that the ventilation openings are not covered during operation.

14 Spare parts



Contact for replacement orders:

Opsytec Dr. Gröbel GmbH

Am Hardtwald 6-8

76275 Ettlingen

Germany

Phone +49 - 7243 - 94 783 - 50

Visit us on the Internet: www.opsytec.de

15 Transport, storage and disposal

The conditions of the technical data apply to transport and storage. Storage is only permitted in closed rooms. The system must be protected against moisture or wetness. Do not expose the system to strong vibrations.

Disposal of the device: The housing and the anodized aluminum parts are disposed of as scrap metal after the plastic parts and fans have been removed. The rest is to be disposed of as electronic scrap.

Environmentally relevant materials: aluminum, ABS, copper, PTFE, polyamide, polyurethane, polypropylene, epoxy resin

Dispose of in accordance with national legal requirements. If necessary, contact the appropriate disposal companies. The system can also be returned to the manufacturer for disposal. The transport costs are to be borne by the sender.

16 Error

Error codes can be queried via the "LError?" command.

Only the last error is displayed.

Error confirmations always with NACK:No such command!

The error code is then displayed in the error register.

If a command is sent correctly, the error is cleared.

general	Error number	Description
no error	000	There is no error

Error	Error number	Description
	100	Switch on without enable/enable
	101	No head detected
	102	Temperature too high (temperature switch)
	103	Temperature too high (temperature sensor)
	104	Power outside tolerance*



The electrically absorbed power of the head* can be queried via the LPowerCons? command. Error is output, irradiation is not stopped.

Data reception error	Error number	Description
LPowerSet	400	Error when receiving data from controller Receive string has the wrong length (message to all)
LPowerSet	401	Character error
LPowerSet	402	Value range > 100.0
LPowerSet	403	Value range < 2.0
LSelect	500	Error during data reception from controller Receive string has the wrong length (message to all)
LSelect	501	Character not "0" or "1"
LedResetAll	900	Reset was triggered but not / not yet performed
Command not recognized	999	Data was received but no command was detected

17 Maintenance



This chapter is aimed at qualified users with maintenance tasks.

The LED system is largely maintenance-free. However, as light sources and LEDs have a limited service life, they must be replaced cyclically.

- We recommend changing the group of LED modules if the irradiance achieved is no longer sufficient.
- If there is an increased build-up of dirt in the surrounding area, the air inlets and outlets must be cleaned regularly, at least every 2 months, with a brush or dry cloth.

	⚠ CAUTION
	Possible damage to the system Do not use compressed air or cleaning agents.

- Only clean the optical components if necessary.
- For cleaning:
 - Only use isopropanol to clean the front screen
 - Switch off the LED system.
 - Remove the LED modules
 - Clean the front glass carefully.
 - Reinsert the LED modules and switch the LED system back on.
 - Set the desired operating mode again.

18 Declaration of Conformity



Manufacturer:	Company name: Opsytec Dr. Gröbel GmbH Street: Am Hardtwald 6-8 Place: 76275 Ettlingen Country: Germany
Authorized person for the compilation of technical documentation:	Company name: Opsytec Dr. Gröbel GmbH Street: Am Hardtwald 6-8 Place: 76275 Ettlingen Country: Germany
Product:	LedControl with UV LED Spot P Water cooled high power UV LED module with LedControl High Power UV LED Module Series L with LedControl LedControl S / 5S / 16S
Type number:	860 606 XXXX 860 607 XXXX 860 609 XXXX 860 610 XXXX 860 615 XXXX

The manufacturer hereby declares that we have developed, designed and produced the above-mentioned product(s) under our sole responsibility and that the product complies with the following standard(s) or guideline(s) in this declaration:

2014/35/EU

"Directive of the European Parliament and of the Council on the harmonization of the laws of the Member States relating to the provision of electrical Equipment for use within certain voltage limits on the market (Low Voltage Directive)".

2006/42/EC

"Directive of the European Parliament and of the Council on machinery and amending Directive 95/16/EC (Machinery Directive)".

2014/30/EU

"Directive of the European Parliament and of the Council on Electromagnetic Compatibility (EMC Directive, recast)".

Ettlingen, 16.02.2022

gez. Dr. Mark Paravia

This document is valid without signature if the person responsible for the release is named in clear writing.

